

LEVEL II

2

TR-102-80

AD A101587

SEA-BASED DEPLOYMENT OF  
FLOATING-LAUNCH MISSILES

DTIC  
SELECTED  
JUL 20 1981

E

December 15, 1980

*Hydra Corp.*

9310 TELFER CT.  
VIENNA, VA. 22180  
(703) 281-4489

DISTRIBUTION STATEMENT A  
Approved for public release;  
Distribution Unlimited

DTIC FILE COPY

81 7 20 015

TR-102-80

SEA-BASED DEPLOYMENT OF FLOATING-LAUNCH MISSILES:  
NEAR TERM AND FAR TERM DESIGN CONCEPTS  
FOR SEA-BASED SURFACE MOBILE MX  
MISSILE DEPLOYMENT

A Study For  
The Office of Technology Assessment  
United States Congress

by  
John E. Drain

Accession For	
NTIS GRAM	X
DTIC TAB	
Unannounced	
Justification	
by	
Organization/	
Report Number	
Contract Number	
DTIC	
<b>A</b>	

December 15, 1980

Office of Technology Assessment  
Congress of the United States  
Contract Number: 133-0830.0

*New*

*412 771*

*15*

UNCLASSIFIED

SECURITY CLASSIFICATION OF THIS PAGE (When Data Entered)

REPORT DOCUMENTATION PAGE		READ INSTRUCTIONS BEFORE COMPLETING FORM
1. REPORT NUMBER HYDRA Corp. TR-102-80	2. GOVT ACCESSION NO. AD-102 557	3. RECIPIENT'S CATALOG NUMBER
4. TITLE (and Subtitle) Sea-Based Deployment of Floating-Launch Missiles - (Near-Term and Far-Term Design Concepts for Sea- Based Surface Mobile MX Missile Deployment)	5. TYPE OF REPORT & PERIOD COVERED Final Report 11/15/80 to 12/15/80	6. PERFORMING ORG. REPORT NUMBER TR-102-80
7. AUTHOR(s) John E. Drain	8. CONTRACT OR GRANT NUMBER(s) OTA # 133-0830.0	
9. PERFORMING ORGANIZATION NAME AND ADDRESS HYDRA Corporation 9310 Telfer Court Vienna, VA, 22180	10. PROGRAM ELEMENT, PROJECT, TASK, AREA & WORK UNIT NUMBERS	
11. CONTROLLING OFFICE NAME AND ADDRESS Office of Technology Assessment 600 Pennsylvania Ave., SE Washington, D.C. 20510	12. REPORT DATE 15 December 1980	13. NUMBER OF PAGES 69 (vii + 62)
14. MONITORING AGENCY NAME & ADDRESS (if different from Controlling Office) 11731	15. SECURITY CLASS. (of this report) Unclassified	15a. DECLASSIFICATION/DOWNGRADING SCHEDULE
16. DISTRIBUTION STATEMENT (of this Report) Approved for public release; distribution unlimited.		
17. DISTRIBUTION STATEMENT (of abstract entered in Block 20, if different from Report)		
18. SUPPLEMENTARY NOTES This study was undertaken in support of an Office of Technology Assessment review of various MX basing options.		
19. KEY WORDS (Continue on reverse side if necessary and identify by block number) MX Basing MX Deployment Sea-Based Missiles Floating-Launch Missiles HYDRA Missiles		
20. ABSTRACT (Continue on reverse side if necessary and identify by block number) This report presents systems concept descriptions for sea-based MX Missiles, using surface ships as transporters. Near-term (1985-1990) and far-term (1990-2000) systems are described. Floating-launch methods are proposed, using either encapsulated missiles or the simpler (bare) HYDRA-type vertical floating launch. Parameters described include: force composition, missile jettison techniques, port facilities, deployment areas, personnel requirements, system costs, vulnerability, countermeasures, and C <sup>3</sup> considerations.		

DD FORM 1 JAN 73 1473

UNCLASSIFIED

SECURITY CLASSIFICATION OF THIS PAGE (When Data Entered)

## PREFACE

The Office of Technology Assessment is analyzing various basing and deployment modes for the MX strategic ballistic missile system. As a part of this effort, they have engaged the services of the HYDRA Corporation to prepare point designs for both near-term and far-term surface ship based MX systems. These designs will be of a scoping level of effort only, due to time and funding constraints. By terms of this study contract with OTA, the MX missile is to be used as a basis for point designs.

The near-term system covers the time period 1985-1990, using existing ships or new ships constructed from existing designs. Minor modifications which will not delay the delivery schedules adversely will be permitted.

The far-term system covers the period 1990-2000. It envisions the use of more advanced technology for both the missiles and the missile ship platforms.

Conceptual designs are described for each time period. Quantitative estimates of various key parameters of interest to program planners and defense analysts are presented. Typical parameters include such items as ship size and performance, crew size, deployment areas, port facilities, life cycle cost estimates, vulnerability, C<sup>3</sup> considerations, and missile guidance accuracies.

This report will address only the technical, cost and schedule aspects of the system. We will leave the political and institutional questions of service jurisdiction to others for answers; i.e., whether the ship would be manned by Navy, MSC or USAF crews, and whether the missiles and their support equipment would be manned by USAF or Navy crews.

For this study it is assumed that the vertical-floating (HYDRA) launch technique is feasible and may be employed where advantageous. In the early 1960s, the U.S. Navy's HYDRA Project demonstrated the feasibility of the floating launch. The Navy successfully fired over fifty floating rockets of widely varying types and sizes. The ability to launch complex electronic payloads (as would be found in ballistic missile warhead and guidance sections)

was repeatedly demonstrated using HYDRA-IRIS ionospheric sounding probe rockets. Over one hundred technical reports, and several dozen government patents, further attest to the technical feasibility of the vertical floating launch.

In the author's opinion, more flexible military systems than we now have will eventually be based on use of the "ideal" or bare floating launch HYDRA rocket. Whether they are long range strategic missiles, short range tactical weapons, or even satellite boosters, the vertical floating launch method represents the ultimate in economy of launch operations. After all, there is no "launcher" required, other than an ocean, lake or river- and these are plentiful and free.

The use of canisters , containers or capsules - although very useful for storage, and transportation, - have proven to be unnecessary in the actual launch. For short periods of time in the water, the rocket experiences the ideal method of support which avoids all stress concentrations. Starting from a statically stable vertically floating position, the rocket accelerates along what amounts to a semi-rigid launch rail. This further ensures a near-vertical launch. Finally, no performance penalties are associated with the floating launch, since anything not used during the flight of the rocket can be left behind in the water.

#### ACKNOWLEDGMENTS

This quick-reaction study could not have been completed without the assistance of a large number of people. In particular, I would like to acknowledge the time and effort devoted by Rear Admiral George H. Miller, USN (ret.), Rear Admiral John H. Alvis, USN (ret.), Mr. Edward S. Gravlin, Mr. Neubar Kamalian, all of whom contributed directly to the study through research, analysis, and discussion.

Also, the assistance of Mr. H. O. Bullock of the J. J. Henry Co., Inc.; Mr. Larry Lorden of Rohr Marine, Inc.; and LCDR Bob Bovey of the Office of the Chief of Naval Operations (OP-372); for their assistance in gathering data on containerships, surface effects ships, and amphibious support ships, respectively, is gratefully acknowledged.

I would also like to thank Drs. Ted Postol and Jeremy Kaplan of the Office of Technology Assessment of the U. S. Congress, for their comments, criticism and guidance, during the course of the study.

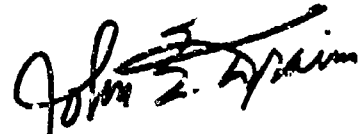
  
John E. Drain  
President, HYDRA Corp.

## TABLE OF CONTENTS

	<u>Page</u>
Foreword. By Rear Admiral George H. Miller, USN (ret.)	v
CHAPTER 1: Summary .....	1
CHAPTER 2: Missile/Capsule Jettison Techniques.....	7
CHAPTER 3: Force Composition.....	21
CHAPTER 4: Port Facilities.....	27
CHAPTER 5: Deployment .....	31
CHAPTER 6: Personnel.....	36
CHAPTER 7: Costs .....	40
CHAPTER 8: System Vulnerability & Countermeasures...	46
CHAPTER 9: MX Missile Capabilities.....	53
CHAPTER 10: MX Ship Strategic C <sup>2</sup> Considerations.....	59

## FOREWORD

by

Rear Admiral George H. Miller, USN (ret.)

The purpose of U. S. armed forces is to preserve and defend the United States. The purpose of U. S. nuclear weapons is also to preserve and defend the United States.

By basing U.S. nuclear weapons inside the United States, we virtually assure that the United States, which we are supposedly seeking to defend, will be destroyed in the initial nuclear exchange.

Moreover, U. S. land-based nuclear weapons targeted at the Soviet Union pose a clear and present danger, from the Soviet point of view, ample reason for them to plan for destruction of U. S. land-based nuclear weapons by surprise nuclear attack.

The belief that the U. S. could retaliate within minutes, rationally and effectively, runs counter to historical human reaction to surprise. Instant retaliation contributes nothing to national defense, if America dies minutes later.

The claim that land-based deployments provide deterrence is also without foundation. An objective analysis of how the Soviets react to the U. S. land-based nuclear deployments cannot escape the conclusion that surprise attack on the United States is high on their list of possible courses of action.

U. S. nuclear weapons must be deployed so as to make it impossible for the Soviet Union to destroy them by surprise attack on United States territory. In other words, an urgent part of the U. S. effort to preserve and defend the United States must be to remove America from the line of fire of an initial nuclear exchange.

The U. S. obviously cannot base its nuclear weapons on foreign territory and still retain full freedom of action to employ them in the defense and preservation of the United States.



A review of most of the better known surprise attacks of history shows that successful surprise can be preplanned and executed only against fixed targets. This finding received support in the Defense Department Strat-X Study of 1967, which concluded that a mobile surface ship-based ICBM system creates "too many uncertainties" to enable an attacker to count on rapid drawdown by surprise attack. Creation of such uncertainty is the very essence of successful deterrence.

By basing U. S. nuclear weapons at sea, the United States can retain full freedom of action to control and employ them in defense and preservation of America. In selecting sea-based weapon modes, one should think in terms of an optimum mix, one that will achieve for the United States the most favorable economic exchange ratio in terms of initial investment, cost of operation, percentage of time at sea, cost of crewing, service life and cost to opponent of tracking and drawing down the system by surprise and attrition. A mix of ships, submarines, and sea-based aircraft, for example, would force the tracking nation to employ a more costly mix of offensive and defensive systems. The capability of U. S. sea-based ICBM systems to present an ever-changing omni-azimuthal cross-targetting capability would put maximum stress on Soviet defense and tracking systems.

Soviet geography makes deployment of their ships and submarines to the open sea more difficult and time-consuming than in the case of the U. S.

With U. S. weapons deployed at sea, the U. S. holds the initiative in terms of selection of routes, operating areas, timing, speeds, tactics, strategy, use of weather, etc., all adding to the cost of the tracking nation.

Additional considerations in sea-basing nuclear weapons systems are:

1. Fog, mist, clouds and darkness exist at sea 75 percent of the time.
2. By selection of areas, courses and speeds, ships can remain concealed from visual observation virtually 100 percent of the time. Other measures, such as electronic deception, jamming and periodic changing of the appearance of ships can add uncertainty to the tracking effort.
3. Missile ships can carry their own communication, jamming and deception devices and can be coordinated and protected by naval forces operating in the same general area.

4. Missile ships can carry their own defensive weapons and operate with naval task forces or in crowded shipping lanes.

5. Previous studies have shown that the relative cost to track a surface ship would be a minimum of three times higher for surface trailing and as high as ten times more for submarine trailing. A trailing submarine would have difficulty concealing its location because of the noise it creates at the higher speeds required.

6. Trailing surface ships would need to be bigger, faster, and have more cruising range than the ship(s) they trail, since the trailed ship could select courses, speeds, and areas designed to add to the cost and difficulties of the trailer.

7. Missile ships would have the option of moving into, out of, and among island groups and shoal waters.

8. Missile ships would be part of the U. S. Navy but need not all be painted grey, or any other uniform color.

9. Missile ships could carry as few as 1 or 2 missiles thus adding still more to the cost of trailing and countermeasures.

10. A previous Department of Defense study showed the relative cost of delivering ICBM's on target from the four platform systems considered most feasible as:

	<u>Relative Cost</u>
a. Surface Ship	12B
b. Submarine	16B
c. Land Mobile	38B
d. Hard Rock Silo	40B

By deploying a minimum number of missiles in each ship - or none, for example - the U. S. could force the greater part of the Soviet Navy and Merchant Marine to participate if the Soviets gave trailing first priority, thereby reducing the Soviet ability to use their ships for offensive or other purposes. But even more important, deployment of U. S. nuclear missiles at sea takes the U. S. out of the line of fire of the initial nuclear exchange. Such are the advantages of gaining the strategic and tactical initiative at sea.

## CHAPTER 1

### SUMMARY

#### 1.1 Summary; Near Term System

The operational concept for the near-term (1985-1990) Surface Ship Mobile MX system involves placing encapsulated MX missiles, along with modularized missile support equipment, aboard high speed, long endurance armed containerships. These would be commissioned as U.S. warships. The nominal missile load for each ship is eight MX missiles, with an overload capability as yet undetermined. Figure 1-1 shows a ship launching missiles.

Seven existing or designed U.S. Navy amphibious ship classes and eleven U.S. Merchant Marine Containership and Lighter-Aboard-Ship (LASH) classes were investigated as MX Missile carriers. The naval ship classes tended to be less efficient from a cost and personnel manning standpoint, in addition to which they were all under 25 knots. The latter deficiency impacts heavily on their potential survivability. Of the merchant ships investigated, they were all more than capable of carrying the required number of missiles and had the potential, with some modifications, of being viable candidates for the MX mission. However, one ship, the SEA-LAND SL-7 class had the added advantage of about ten knots in speed over all the other merchant ships (and all the amphibious ships looked at as well). The SL-7, and a scaled down SL-7 (800 ft length vice 946 ft) were selected for further study. Cost analyses were prepared for acquisition of two Navy ship classes- the LST and the LSD, and for two merchant ship options- a force consisting of the eight existing SL-7's plus 22 new construction SL-7's, and another with the eight existing ships plus 22 new construction scaled-down SL-7 types. Note that the Life Cycle Costs for the Navy ship assumed new ship, dedicated construction, in order to avoid any impacts on Navy/USMC amphibious mission assignments. Any diversion of existing assets to the MX mission would obviously drive the costs down.

The SL-7, as stated, is quite a unique ship. It is capable of 33 knots; possibly up to 35 knots at the light loading which would be common for the MX mission. Their speed is derived from their fine lines, their length, and their twin-screw, twin-turbine engines of 120,000 total installed shaft horsepower. In fact, their high speed will permit them to outrun most

modern warships. Operating them close to friendly bases and refueling ships, and at much greater distances from Soviet bases, the problems presented to the Soviets in trying to detect, locate, identify, trail, and finally destroy these fast MX ships becomes largely unmanageable.

To further complicate the Soviets' problem, it is proposed to extend the range of the MX missile to 7500 nm. This would be done largely by a slight lengthening of the missile and addition of extra, low-density storable fuel to the upper (fourth) stage motor. This would also have the effect of reducing the specific gravity, and rendering the missile capable of self launch from the water, with or without a cannister or capsule.

Only after receipt of an Emergency Action Message (EAM) and insertion of programmed target coordinates and other guidance information into the missile, would the missile be placed in the water. Then, it would be dropped into the water, where it quickly erects to the vertical position, and the rocket main stage fires to propel it upwards on its trajectory. The estimated time from dropping into the water to launch is less than one minute.

The total potential operating area from which the MX missiles can reach any point within the Soviet Union is estimated at 73 million square nautical miles ( $\text{nm}^2$ ); of this total area about 20 million  $\text{nm}^2$  has been selected as a primary operating area which has many advantages for the U.S. and few if any for the Soviets, to operate in. The remaining 53 million  $\text{nm}^2$  lies in a belt completely encircling the earth, yet remaining clear of unfriendly territory. (A passage, out of missile range, around the southern tip of South America, is included in this area.)

The threat from Soviet aircraft within the primary operating area is virtually nil; that from Soviet ships can be minimized by a wide variety of concealment and deceptive measures. Soviet submarines present probably the most serious threat, and here the speed of the MX ship becomes a great advantage. It is considered by many naval officers with command experience that survival of a high percentage of such ships is assured, even after several days of hostility. There is an urgent need for more study in this area; it is an extremely complex problem, involving a myriad of factors.

There is some question whether the Soviets would even attempt to conduct trailing operations on each ship of the MX Force, in the primary operating area. To do so would cost them dearly, forcing an expensive remodeling of their naval forces- building entirely new classes of ships. It would also force them to engage in a very expensive program to expand their satellite ocean surveillance capabilities by orders of magnitude, and to rely entirely on the very expensive active sensor types, as opposed to the passive sensors which require emissions from the quarry.

#### 1.2 Summary; Far-Term System

The far-term system is based on continued use of 15 of the original 30 fast containerships. This force is augmented with 45 very fast, new generation lighter displacement ships. These would most probably be of the Surface Effects Ship (SES) type as shown in Figure 1-2. The nominal missile loadout is four missiles per SES. The SES's are capable of speeds of up to 90 knots.

There would be several ways of operating this force, depending on existing conditions. One way would be to assign three SES-MX's to each SL-7, with the latter acting as a "mother-ship" furnishing support both operationally and logistically. Another mode would be to operate small groups of SES-MX's out of advanced bases- having some out to sea at all times, with the remainder at "ready-alert" prepared to scramble out to sea much in the nature of SAC's manned bombers.

The development of tactics, deployment strategies, and standard operating procedures for the far-term system will no doubt benefit greatly from lessons learned in the near-term. This would be true whether the near-term force were based on naval (amphibious) type ships or the preferred fast containership class ship.

The 15 SL-7's which would be retained as Mother-ships would continue to operate as missile carriers, in addition to supporting the SES-MX's. Some modifications might be needed. One would probably be added fuel tank capacity to refuel the SES's either underway or in austere advance bases or anchorages. Another modification which should be seriously considered, if indeed it had not already been placed in use during the near-term period, is the installation of a helicopter deck on the SL-7, and helo landing

platforms on the SES's. For the SL-7, the ARAPAHO concepts developed by the Naval Air Systems Command could be employed. Briefly, this involves the installation of a strap-on helicopter V/STOL flight deck, hangar shed and other necessary equipment for conducting underway flight operations from standard containerships. Advantages to having helicopters as a part of the force would be many. They could act as scouts to check over-the-horizon targets, without breaking radar silence. They could deliver secure messages and communications either within the force or to on-shore base facilities. They could also perform emergency personnel transfers in the event of injury or illness, either to the SL-7 (which would have more complete medical facilities than the SES class) or to hospitals ashore.

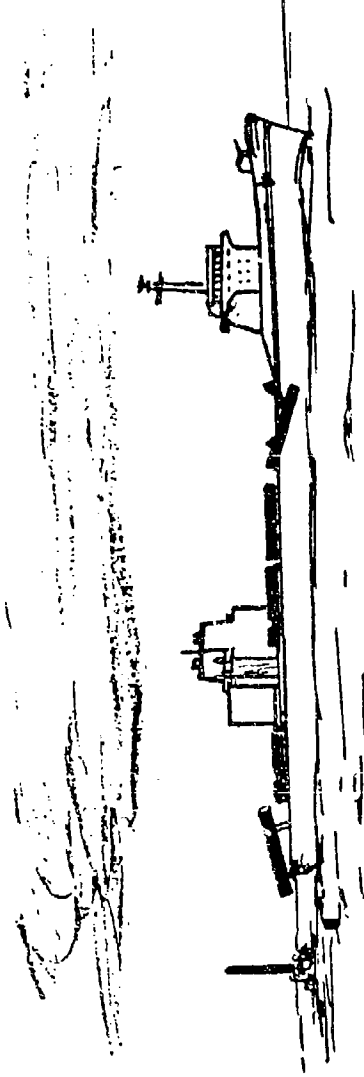
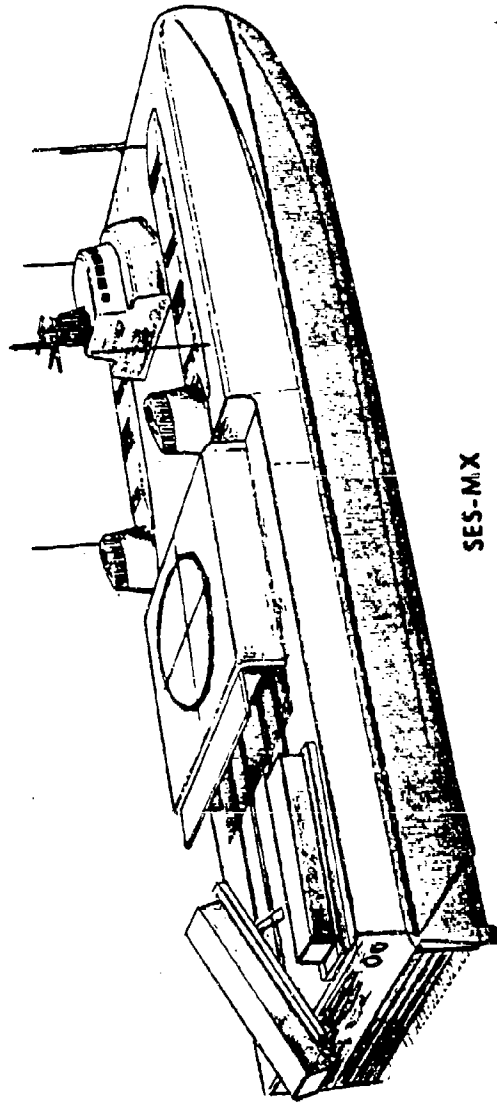

Figure 1-1  
SL-7 Type Near-Term MX Baseline Ship

NK 12/11/80



SES-MX

NK 12/11/82

Figure 1-2  
SES-MX Type Far-Term Baseline MX Ship



CHAPTER 2  
MISSILE/CAPSULE JETTISON TECHNIQUES

2.1 General Discussion

The methods of launching rockets or missiles at sea have been quite varied in nature. The obvious and most direct method is to launch directly from the deck of a ship; this is often called the "hot" launch. The U.S. Navy used large batteries of deck-launched spin-stabilized bombardment rockets on the decks of converted amphibious support ships (LSMR's) in attacking Japanese held islands. Both the United States and the Soviet Union have launched scientific sounding probe rockets directly from the decks of naval and oceanographic ships. Surface-to-air missiles fired from automatic, trainable launchers have become quite common on naval ships of many nations.

The Germans, in WWII, engaged in a development effort using an encapsulated V-2 missile. It was to be towed behind a submarine, either surfaced or submerged. In the target area (the Germans had New York City in mind) the capsule would be ballasted to the vertical, a lid would be opened at the top, and the rocket fired out of the capsule. It never became operational, but there is some evidence that the Russians experimented with this technique after the war, using captured German technicians.

2.2 Some Methods of Implementing a Floating Launch

The vertical floating launch of bare missiles of specific gravity less than one (buoyant missiles) has been demonstrated by both the U.S. and the USSR. This method is particularly adapted to storable liquid propellant rockets (which the Russians seem to prefer) because storable liquids are less dense than solid propellant fuels. The advantages seem to increase with the size of the missile; obviously, firing a very large missile from the deck of a pitching ship presents some serious safety hazards.

Adaptive methods, wherein the missile or rocket is waterproofed, but added buoyant or ballast devices are added to float the missile in a stable, vertical position, has been frequently used. A considerable number of rockets were fired in this manner by the U.S. Navy's HYDRA Project in the early 1960's (as well as a few bare and some encapsulated rockets).

The U.S. Navy's submarine weapons programs also display other methods of launch. HARPOONS and TOMAHAWKS are propelled horizontally out of standard 21" torpedo tubes, and are then programmed upwards at an angle to exit the water. The main rocket stage or booster stage is not ignited until it is safely clear of the submarine. Similarly, U.S. SLBMs are propelled vertically upwards from missile tubes by a gas generator, where they also are ignited only when safely clear of the submarine (usually after they have broken the surface).

The use of the vertical floating launch avoids the necessity of using a gas generator or other means of propelling the missile out of the tube or container in which it is kept aboard ship. The missile can be merely dropped in the water (or floated up from a submarine) and this can be done either encapsulated or bare. Missiles already in operational use are usually easier to launch using a capsule; this is because they are not usually the proper specific gravity, or the cg to center of buoyancy distance is not suitable. Thus, it would be most expedient to consider launching missiles such as MX or TRIDENT from a vertically floating capsule. This represents a readily available, near term solution to putting such missiles out to sea without extensive redesign. (The Navy's HYDRA Project looked into encapsulating both POLARIS and MINUTEMAN in the period 1961 through 1965).

The long-term solution may well be the bare, unencapsulated type missile. The missile could still be kept in a container or capsule until just before launch, when just the missile would be slipped into the water. This way, the capsule could be saved and re-used rather than sunk to the ocean floor. Thus, it is potentially, at least, the least expensive of launch methods. Also, there is no danger of interference between the missile and the capsule from which it must be separated. This interference can take the form of direct mechanical contact; one aerodynamic fin was broken off a HYDRA-IRIS rocket after striking the corner of its buoyant rail-launcher. The interference could also take

a more subtle form- the pressure field created by the nozzle firing inside the capsule. The underwater nozzle firing of a bare missile is characterized by a low-level pulsating pressure field. It arises due to the under and over-expansion of a pulsating bubble of gases outside the nozzle. The only restraint on the gas motion is the inertia of the water. A more constrained situation with firing inside a capsule might have more serious consequences and would be more likely to cause damage to the missile.

## 2.2 Missile Encapsulation

Encapsulation provides a number of features which can enhance the practicality of sea-based missiles. First, the capsule can also act as a shipping container for the missile, protecting it against physical damage, or damage from exposure to extremes in temperature, humidity or other environmental factors. A completely controlled environment can be maintained in the area immediately surrounding the missile. One can use an inert, dry gas environment within the waterproofed capsule. One can also support the missile in shock or vibration absorbing material. The temperature can be precisely controlled through thermostatically controlled heating or cooling units.

Another important function which can be performed by the capsule is the housing of ancillary check-out, monitoring, programming, and guidance equipment(in some cases). If the equipment is to be carried outside the capsule, then the necessary electrical interconnects can be provided by the capsule. Any and all of the equipment which is not necessary during the flight of the missile can thus be left behind, either in the capsule or aboard ship (for equipment which is hooked up by external disconnects).

Yet another function of a capsule is to prevent monitoring by unfriendly agents or intelligence sensors, of the missiles themselves. Intelligence may thus be denied.

Even though a missile is to be encapsulated, there still may be advantages to designing the missile to have the capability of self-launch without the capsule. Thus , it can be launched either way, giving it a great deal of flexibility, and possibly facilitating its launch from other

types of ships or platforms. In some cases, it was found, during Project HYDRA research, that NASA and rocket manufacturers had unwittingly designed "ideal" HYDRA-type rockets. That is, the rockets were ideally suited to a bare, vertical floating launch without any redesign at all. Usually, this occurred when the upper stages were liquid, and the first stage or booster was a solid propellant. An example of this was the AEROBEE 350 (which was never, unfortunately, launched from a floating position.)

A useful function of the capsule in the applications involving jettison overboard from surface ships is the ability to absorb the stresses involved in physically dropping into the water. It was found in many cases, in fact all, that the missiles themselves could be dropped from reasonable heights of up to about 30 feet and sustain no damage. But, just to be safe, the capsule provides extra protection. Many tests in Project HYDRA saw the missiles lowered into the water by cranes or boat davits. This resulted in a gentle water entry, but possibly not well suited to a fast tempo of missile launchings as would be necessary at the outset of nuclear war. Dropping many missiles almost simultaneously into the water appears to be a much quicker method of deploying them.

Once the missile in its capsule is floating vertically in the water, having been released from the parent platform, it could be easily fired directly out of the capsule. Or, the capsule could be sunk away from the missile (assuming the missile has the proper buoyancy) leaving it unencumbered in the water, ready for a "bare" launch. If the firing takes place with the missile still in the capsule, a sabot or seal at the lower end of the missile may be required to avoid excessive "blowback". One can be assured that the capsule will accelerate downwards, and the rocket upwards, with rapidity.

### 2.3 Loading and Transporting

As previously indicated, the capsule serves as a shipping container, as a strongback protection against impact loads from cropping into the water, and possibly as a vertical-floating launch guide-rail. The capsule is loaded with the missile at the missile checkout and assembly facility, and then transported to the ship. At the ship, the capsules may be loaded

using the ship's own crane facilities, or pier mounted travelling cranes. The capsules could be loaded aboard either on the main deck, or below decks. If loaded on the main deck, and it is felt undesirable to have the capsules exposed (either to the elements or to prying eyes) a temporary deck house or sliding hangar arrangement could be trundled over them. Since the MX Ship does have its own crane facilities, operation at advanced bases and anchorages will be facilitated.

#### 2.4 Use of capsules as decoys

Ships having capsules visible above decks can act as decoys. (Capsules may be empty or full). Recce aircraft, photo satellites, trailing ships or submarines may be forced to assume from the presence of the capsules that there are missiles aboard, whether or not this is the case. If the launch system were known by the enemy to be in wide use from a large number of ship platforms, many ships could carry empty containers around to cause the enemy to disperse his efforts and dilute the quality of his surveillance coverage. Since almost any containership (over 100 in U.S. Merchant Registry) and almost any Navy amphibious ship (over 60 on active naval service) have the capability of launching floating missiles, the number of potential carriers is quite large.

#### 2.5 Jettison Techniques

There are many methods for placing capsules containing missiles, or floating missiles, into the water. From a surface vessel, techniques will depend in some measure on the type of vessel, the speed at which it is moving through the water, how far the missile has to drop before striking the water, and the degree to which the vessel has been adapted for the mission.

In the near-term, the use of fast armed containerships suggests the development of methods for rapidly sliding missile capsules over the side or off the stern of the ship as shown in Figures 2-1 and 2-2.

For existing Navy ships, missiles can be checked out using modular support equipment. Of course, there will be requirements to furnish secure compartments, extra firefighting and damage control systems, and the like; but as for physically putting missiles into the water, very

little, if any, sophisticated equipment or hardware is needed. Figure 2-3 shows the method used for well-deck type ships in the amphibious fleet, such as the Landing Ship Dock (LSD), Amphibious Transport Docks (LPD) and Landing Ship, Tanks (LST) types. Even aircraft carriers could be pressed into service, should this be required, recognizing that the tempo of flight operations would most likely be affected. One arrangement which would have the least impact on flight operations would be a vertical jettison from outboard of the island on the starboard side. This would require construction of a special missile compartment, with access doors which would open only moments before jettison. This is depicted in Figure 2-4. Another system would involve jettison from the hangar deck level; although no major ship alterations would be required as for vertical jettison, there would probably be more interference with the operation of aircraft. This type of jettison is shown in Figure 2-5. For this jettison, it is assumed that the deck edge elevator is in the "UP" position (at the flight deck level).

For the far-term systems, using Surface Effects Ships (SES) several approaches are possible. Probably the most straightforward is the capsule slide as shown in Figure 2-6.

Several other possibilities are shown in Figures 2-7 and 2-8. In summary, there are a large number of variations in the jettison methods, and there are no serious problems in developing and testing the techniques with dummy handling capsules or missiles. It is recommended that, if sea-basing is to be taken seriously, a containership be dedicated to perfecting the basic method to be used particularly while the ship is moving at various speeds.

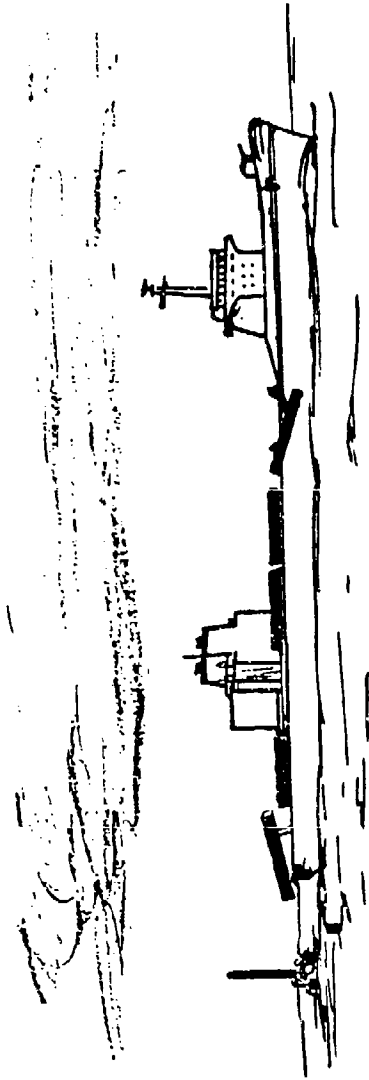

Figure 2-1

Containership Using "Slide-off-Stern" and  
"Slide-off-Side" Methods

NK 12/11/80

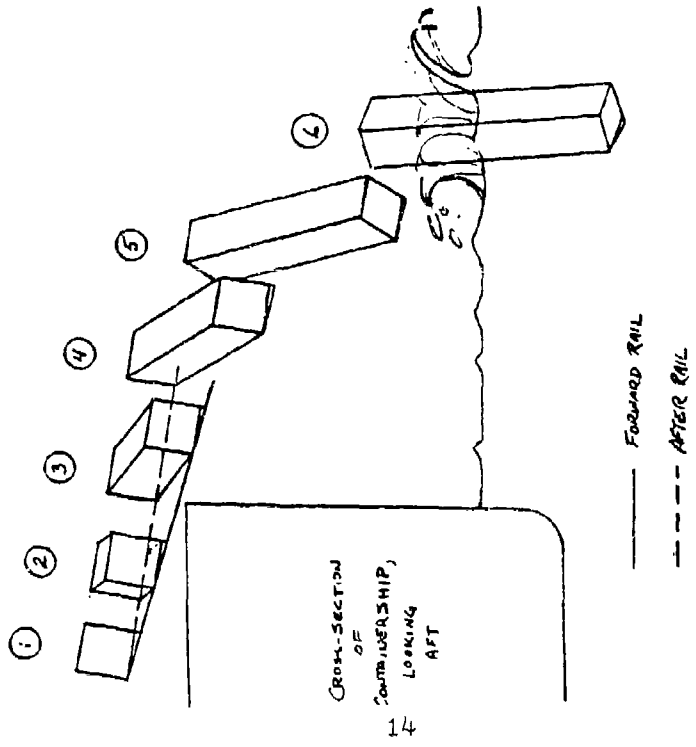
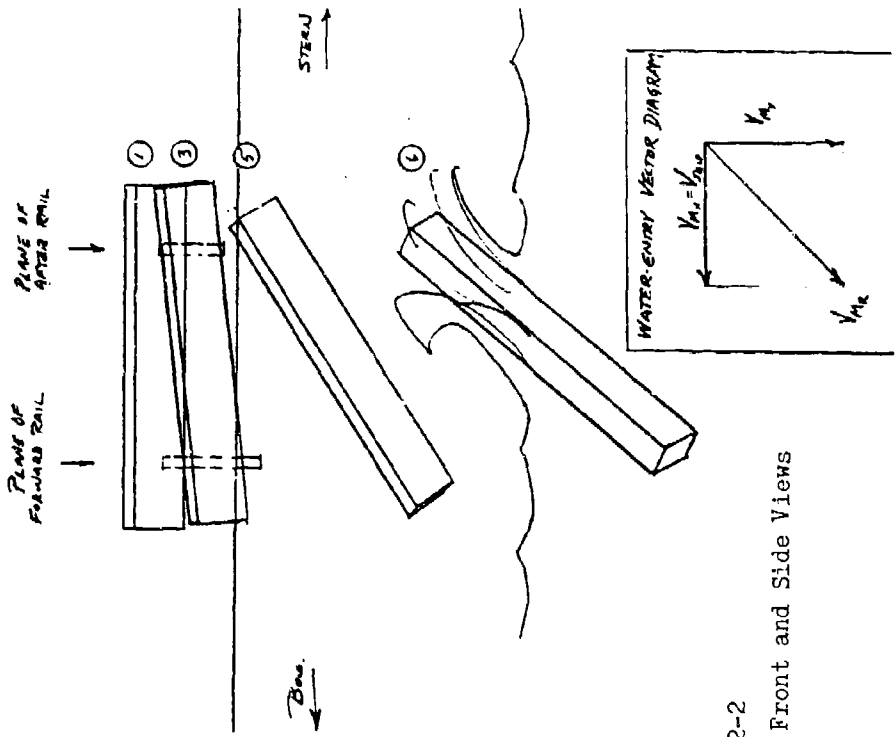

Figure 2-2  
 "Slide-off-Side" Method, Front and Side Views



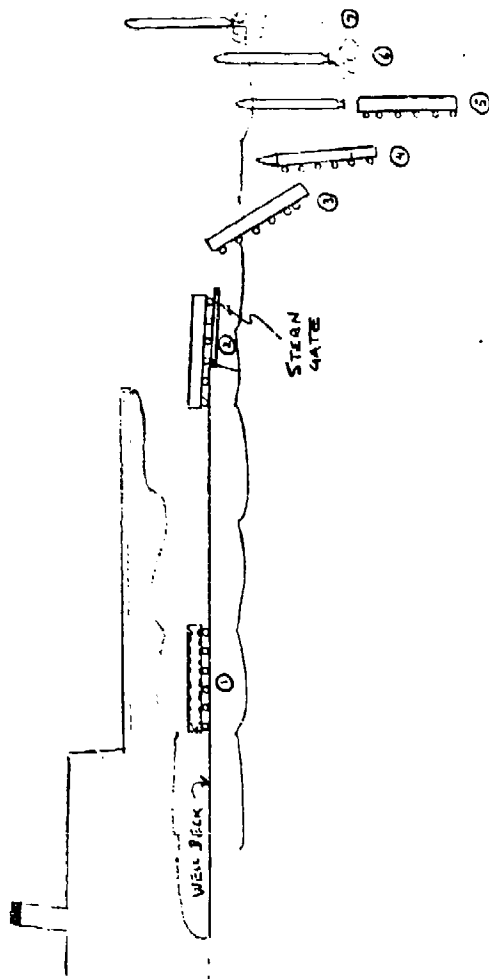

Figure 2-3

Well-Deck Jettison from LSD, LPD, LST Ships

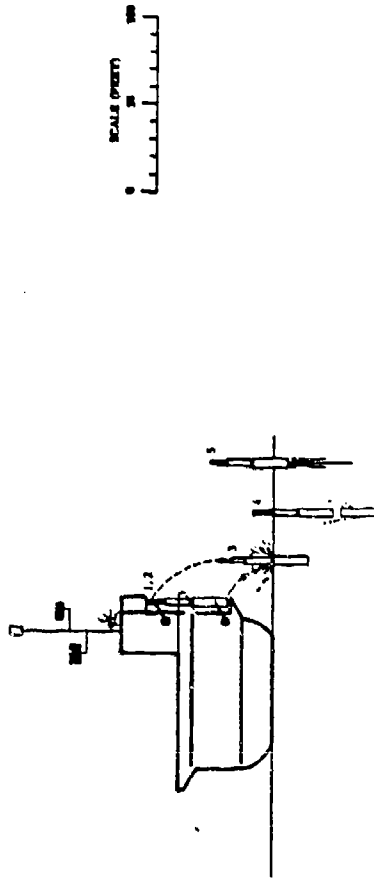
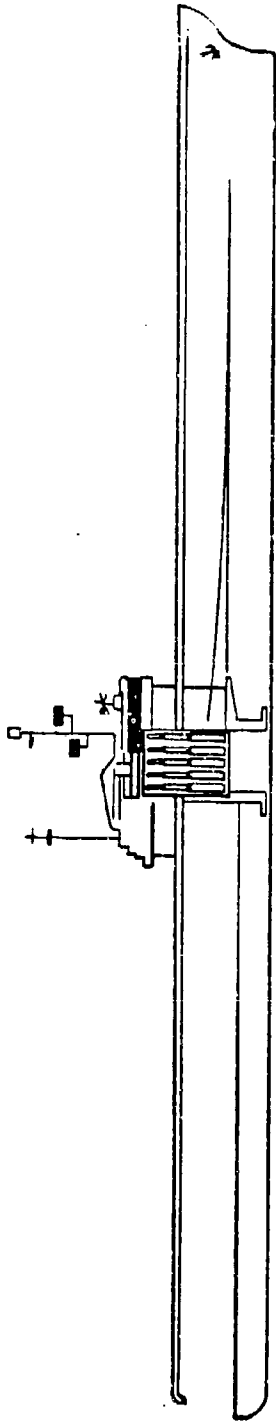

Figure 2-4  
Vertical Jettison from CVN

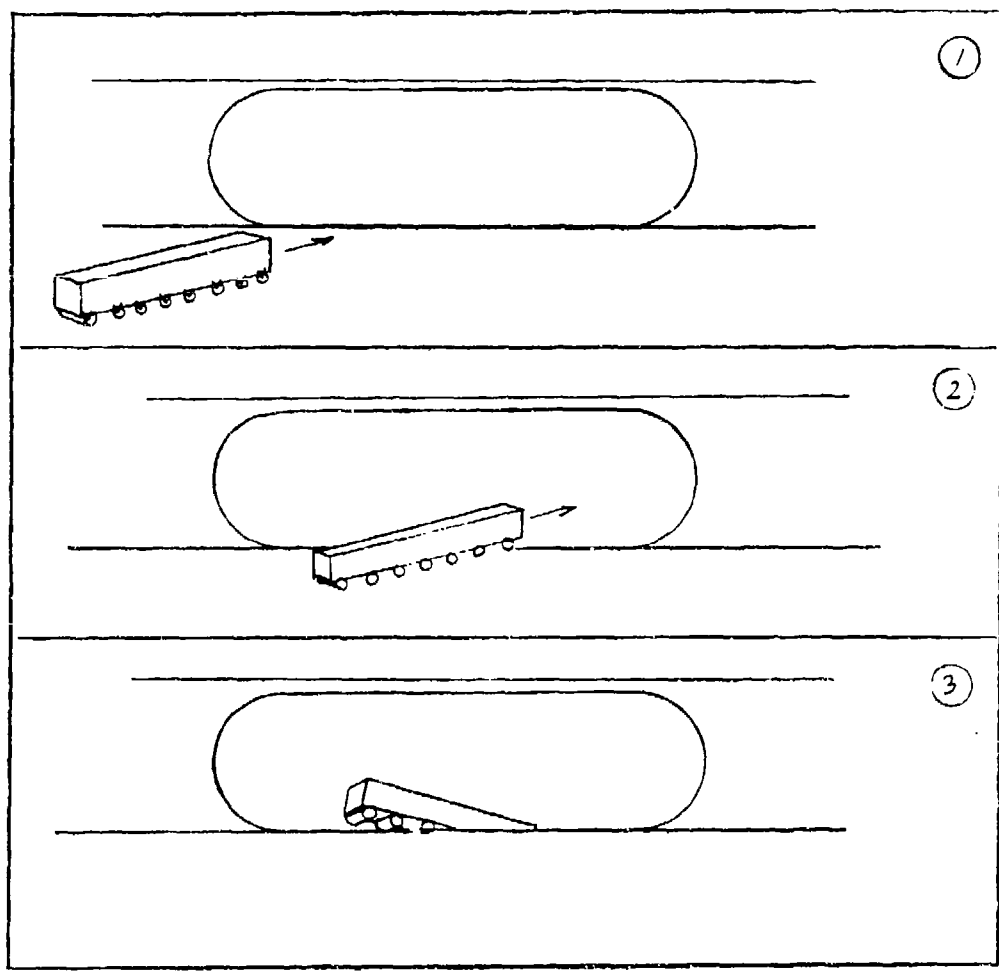
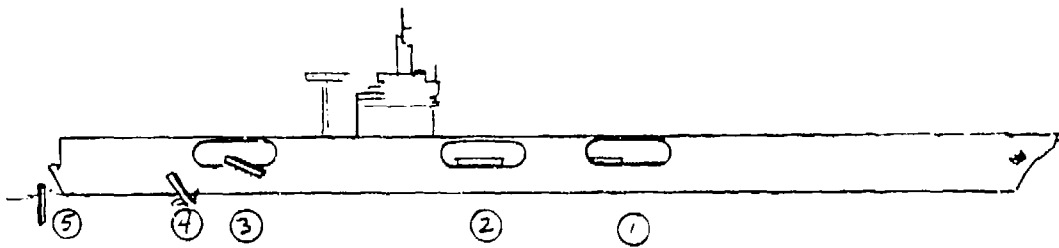
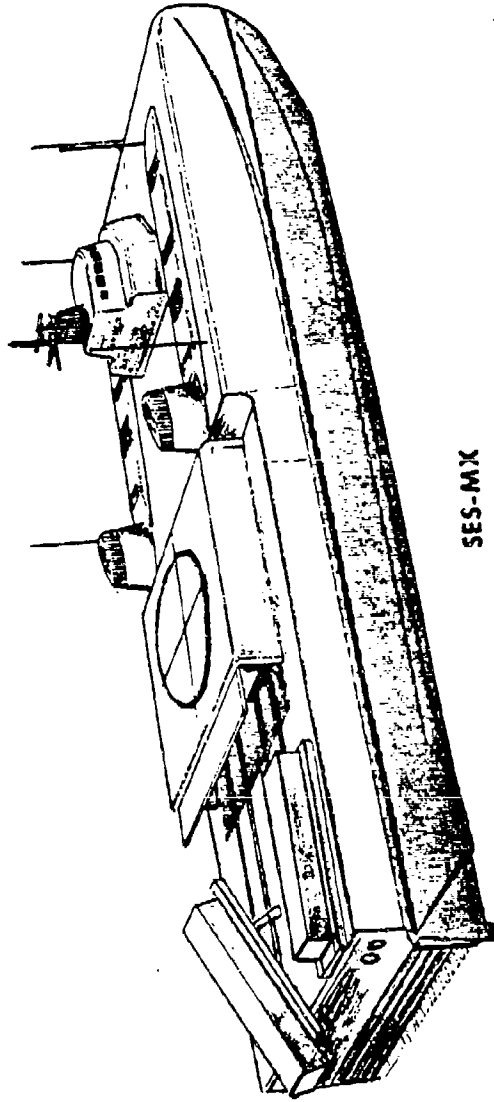

Figure 2-5  
Jettison from Hangar Deck of CVN



SES-MX

NK 12/14/80

Figure 2-6  
"Capsule-Slide" Method of Jettison

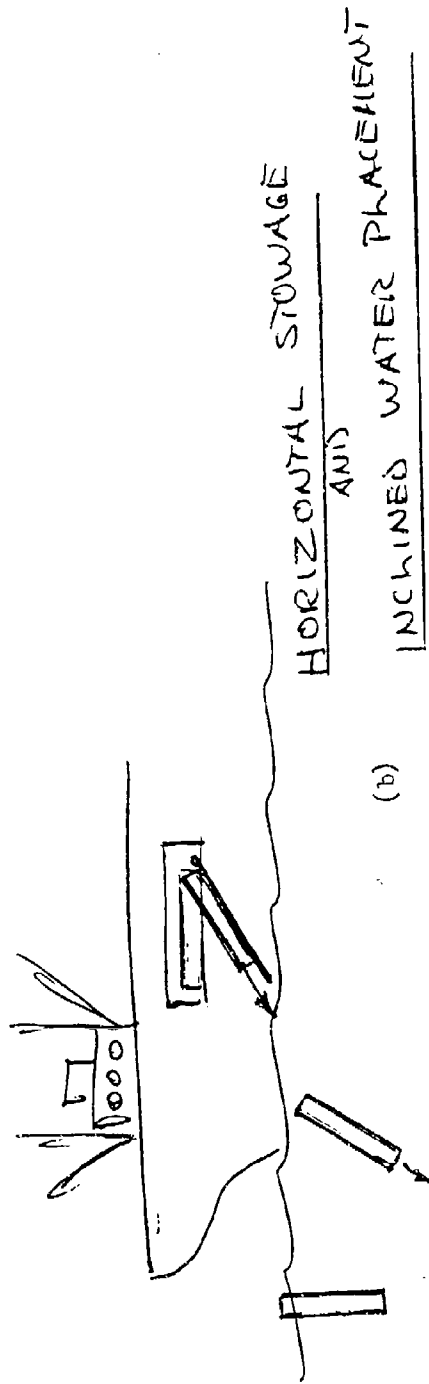
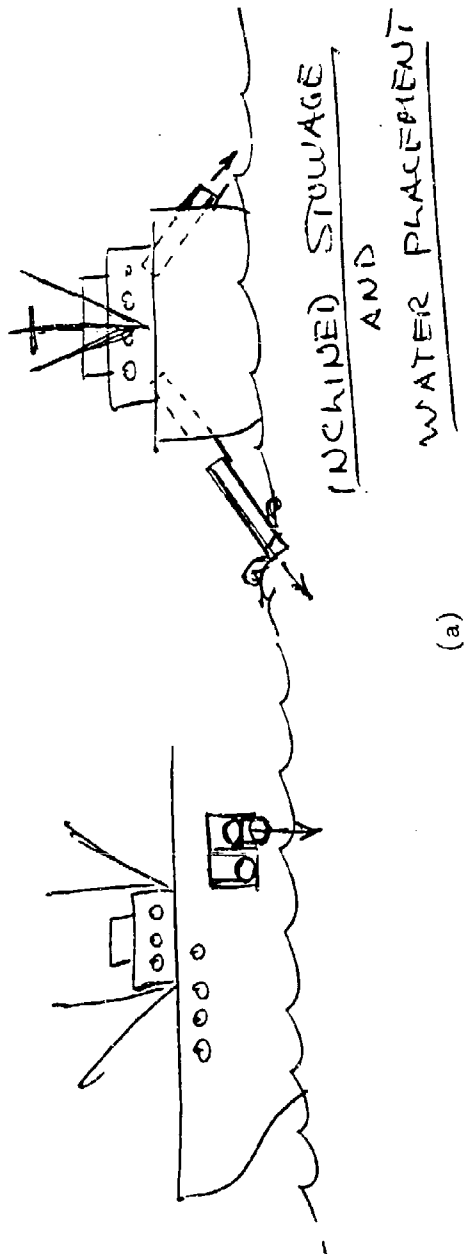
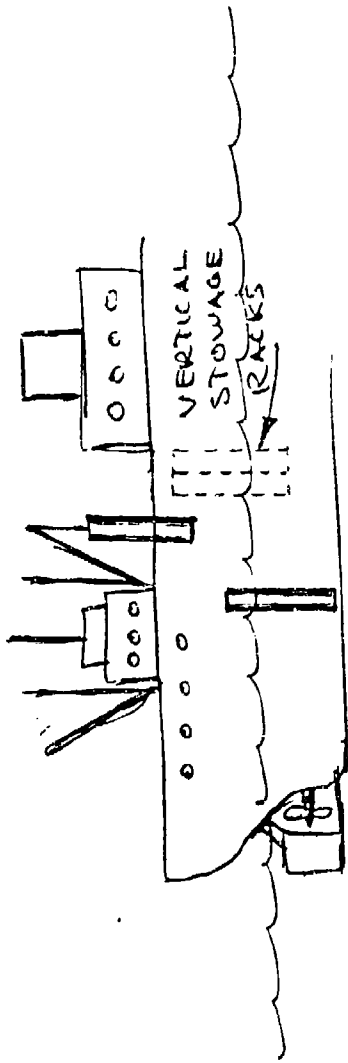

Figure 2-7

"Capsule-Slide" Variations

N. KAHALIAN  
10/16/80



VERTICAL STORAGE  
AND  
WATER PLACEMENT  
MANUALLY

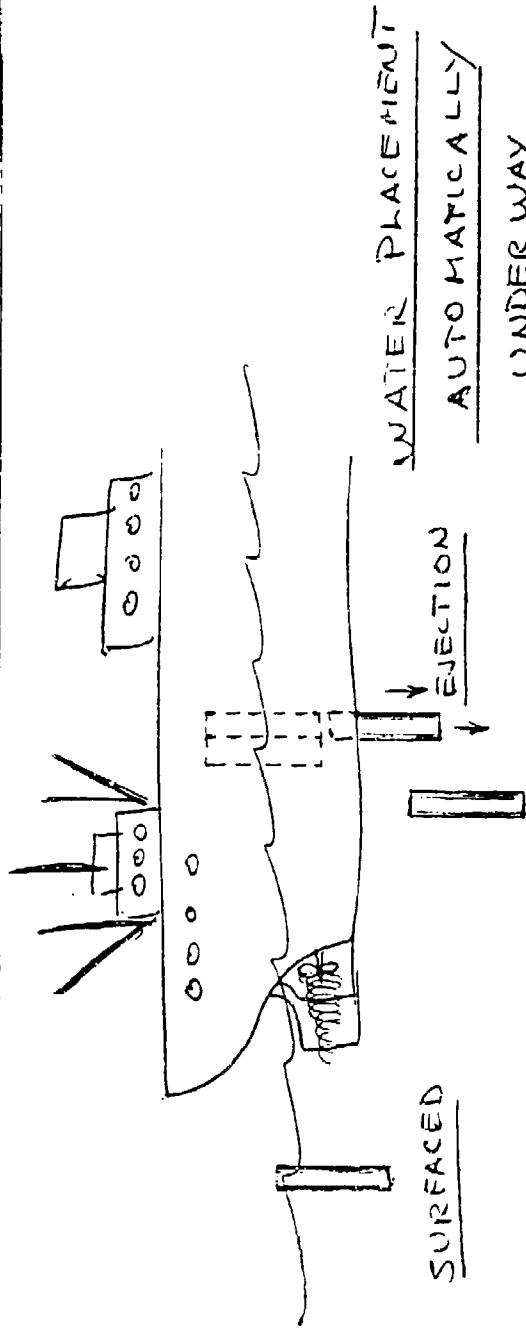

WATER PLACEMENT  
AUTOMATICALLY  
UNDERWAY

DWELL

N. KAMALIAN  
10/16/80

Figure 2-8  
Vertical Placement Variations

## CHAPTER 3 FORCE COMPOSITION

### 3.1 Force Composition: Near-Term

We have selected 30 fast containerships of the SL-7 type for the near-term point design system. Eight of these ships are now being bought from the Sea-Land Corp., by the Department of Defense for about \$36M each. An additional 22 ships would be constructed to complete the force. Since the ships are basically modern merchant hulls, it is planned to use modified merchant ship overhaul and repair cycles, giving an at-sea time factor of about 92%. This means that 27 or 28 ships should be at sea constantly. Using a nominal missile load-out of 8 MX missiles per ship, there should be over 200 MX missiles at sea at any one time. See Figure 3-1.

### 3.2 Force Operations: Near-Term

The 30-ship SL-7 force would be operated in a dispersed manner, using tactics, maneuvers and countermeasures as described in other chapters to ensure survivability. Joining with other naval task groups or ships during trans- and post-attack scenarios would be a general rule, insofar as possible. The speed of the SL-7's will allow them to follow all maneuvers, and special procedures and formation stations would be assigned so as not to interfere with task force operations. Being close to the force at this time period would afford maximum protection from task forces defenses, such as SAM and ASW defenses.

Although not included in the system point design nor in total system costs, the use of a number of Navy amphibious class vessels as potential MX carriers should be considered. This would represent an additional, surge capability using ships in existence - already bought and paid for. The flexibility of the floating launch methods permits the use of those types of amphibious support ships having large well decks opening to the sea, as ideal missile platforms. This was demonstrated at the Naval Missile Center in 1960 and 1961, with the USS Alamo, and USS Point Defiance, both LSD's. Using encapsulated missiles and modular missile support equipment, rapid transfers of missiles and crews may be made to these ships to allow

for a rapid expansion of capability in total numbers of missiles, or for wider dispersion for survivability, or both. Since the SL-7's will have integral 150-ton cranes installed, missiles and support equipment can be transferred from the SL-7's to these types of Navy ships at advance bases. Or, the missiles in their capsules, along with support equipment, could be loaded on board at the main bases which support the MX system.

A survey was made of Navy ship types most suited to perform a missile transport and floating launch scenario. These ships are:

- Amphibious Assault Ships (LHA), 39,300 tons, cap'y 12 MX missiles
- Amphibious Transport Docks (LPD), 17,000 tons, cap'y 6 MX missiles
- Landing Ship Dock (LSD), 13,600 tons, cap'y 12 MX missiles
- Landing Ship Tank (LST), 8,450 tons, cap'y 3 MX missiles

Major drawbacks to the use of these ships are that they are assigned other missions, to support USMC amphibious landings or general logistics functions in the moving of heavy military equipment and troops. Also, they are relatively slow:

- LST: 20 knots
- LSD/LPD: 21 knots
- LHA: 24 knots

Other disadvantages are that they are relatively wasteful of manpower for the MX mission, and thus manning and total operating costs are rather high. They suffer from spare parts problems to some degree. In spite of their disadvantages and their assignment to other tasks, they are versatile ships and could perform the mission of carrying the missiles and getting them in the water, in a launch condition. In the event of war, improvisation often becomes the order of the day, and one should not overlook this potential alternate use for the Navy's amphibious fleet. Further data on these ship types may be found in Figure 7-2.

### 3.3 Force Composition: Far-Term

For the far-term point design, we propose the retention of 15 of the SL-7 vessels. Forty-five SES-MX or other small, high speed equivalents would be constructed. These could be distributed either



to advanced bases for operations, or to an SL-7 which would act as a mother-ship while retaining its own integral MX missile launch capability.

#### 3.4 Force Operations; Far-Term

The far-term force composition of 15 SL-7 type ships and 45 SES-MX type ships could operate in several different modes. In one mode, each SL-7 could act as a mother ship to three SES-MX's. They would have the capability of exchanging missiles for deceptive purposes, and for repair and maintenance, while in calm waters as would be found at an advanced base anchorage. The make-up of this type of task group is reminiscent of the historic Navy destroyer squadron which generally had a cruiser as a "mother ship". This type of task group could also perform credibly as a tactical sea-control force, capable of exerting rapid pressure on Sea Lines of Communication (SLOC). Since these ships would be spending a high portion of their time at sea anyway, with their MX missiles at the ready, they might well be designed and developed to perform both these missions simultaneously.

In operating from advanced bases, the SES-MX's might resemble somewhat the old PT Boat Squadrons. They could spend more time at the port (with an appropriate percentage at sea at any one time). Then, in the event of crisis or heightened international tension, they could all be dispersed in the ocean area surrounding the advance base.

If opponents' reactions to the far-term system indicate an increasing degree of vulnerability to the SL-7's, then the missile load-outs of the SES-MX's could be increased with a corresponding reduction of the number of MX's carried by the SL-7's.

The 15 SL-7 type ships retained in the far-term may, and probably would require some modifications to facilitate support of the SES-MX ships. Primary among these modifications would be added fuel tank capacity to allow them to act as tankers for the SES's. Refueling provisions should allow for both in-port or underway replenishment. No particular R&D would need to be expended in this area as the U.S. Navy has highly developed systems and techniques already in operation. Still another modification which should be seriously considered, if indeed

it had not already been placed in operation by the near-term force, is the installation of a helicopter deck. Using the ARAPAHO concepts under development in the Naval Air Systems Command, strap-on helicopter/VSTOL flight decks tailored to the containership class (of which the SL-7 is a member) are installed. A hangar shelter and other modularized support equipment is also placed aboard. There would be many advantages to having helicopters aboard the SL-7 mother ships. Each SES-MX could have a small helo landing area on the deck space available with its broad beam. The helicopters could perform as scouts; over-the-horizon contacts could be checked out without breaking radio or radar silence. Also, these helos could periodically land aboard naval vessels or advance bases in order to transfer secure communications and messages. Finally, they would be useful in transferring personnel from the SES force who were ill or injured, to the medical facilities aboard the SL-7 mother ship or to shore hospitals.

Figure 3-1

SEA-BASED MX MISSILE FORCE STRUCTURE (NEAR-TERM)

- o Ships: 30 Fast Containerships, SL-7 Type
- o Main Bases:
  - Norfolk, VA
  - Biloxi, MISS
  - San Diego, CA
  - Pearl Harbor, HA
- o Advance Bases/  
Transloading Sites
  - Guam
  - Kwajalein
  - Anchorage
  - Truk
  - Pago Pago (Samoa)
  - Christmas Is.
  - San Clemente Is.
  - Chatham Strait, ALASKA
  - Galveston, TX
  - Key West, FL
  - Mobile, AL
  - Roosevelt Roads, PR
  - Naragansett Bay, RI
  - Pencobsot Bay, ME
  - Puget Sound, WA
- o Navigation/  
Guidance  
Support
  - ICPS Transmitters at numerous locations
  - GPS Tactical Supplement @ 135W Long.
  - Acoustic Bottom Transponders at various locations
- o Nominal Missile  
Load per Ship
  - Eight MX Missiles per SL-7

Figure 3-2

SEA-BASED MX MISSILE FORCE STRUCTURE (FAR-TERM)

- o Ships: 15 Fast Containerhips, SL-7 Type  
+ 45 SES-MX
- o Main Bases: Same as Near-Term
- o Advance Bases/  
Transloading Sites Same as Near-Term
- o Navigation/  
Guidance Support Same as Near-Term, plus Advancements
- o Nominal Missile  
Load per Ship Eight Missiles per SL-7  
Four Missiles per SES-MX

## CHAPTER 4 PORT FACILITIES

### 4.1 General

The location of port facilities is a key factor in the effectiveness of a sea-based MX deployment system. Bases should be distributed rather evenly wherever possible, to provide quick access to or assistance from the port facility, and from other naval or air units operating in its area. The rationale and requirements for selection of main and advance bases and ports are basically the same for the far-term as for the near-term. Basically, there are two major requirements for this strategic system:

(1) the need for furnishing docking facilities for the provisioning, refueling, upkeep and repairs to and including major overhaul, of the MX ships, and

(2) the facilities, space, and secured area surrounding the area in which nuclear weapons and components are stored, repaired, checked out, and assembled, for the missile portion of the system.

A list of the Main Bases and Advance Bases/Transloading Sites is given in Figure 4-1. A Mercator plot of these bases is presented in Figure 4-2.

### 4.2 Ship Requirements

The selection of ports to support the sea-based MX system must, as noted above, provide adequate services to the MX ships. Channel depth requirements will be based on the normal operating draft of 30 feet. A more severe requirement probably will be the radius of the anchorage circles, due to the length of the vessel.

We have selected as Main Operating Bases, for the Pacific Area, the U.S. Naval Shipyard Pearl Harbor, Hawaii, and the U.S. Naval Amphibious Base at San Diego, California.

For the Atlantic and Gulf of Mexico Area, we have selected Norfolk, Virginia, and the Biloxi/Pascagoula region of Mississippi. At Norfolk, there are a number of large piers which have long been used to dock aircraft carriers, along with extensive warehousing, repair and refit facilities. Major dry-docking capabilities exist at nearby Newport News. At the Biloxi area, the drydocking facilities exist for handling the largest of ships, but

since no naval or military base infrastructure exists in this area, it would require additional construction which would be unnecessary at the other locations such as Norfolk.

#### 4.3 Nuclear Weapons Handling Facilities

Warhead assembly, checkout, installation and repairs must be accomplished at a secure installation, and one satisfying certain rules on safety separation distances. Using the concept of the MX-ship and the modularization of missiles (capsules containing missiles being a module) many of these activities could be carried on at a site other than that used for, say, major overhaul of the ship. We contemplate the use of a more remote site where these sensitive warhead storage, assembly, checkout and loadings can be performed. In the case of San Diego, for example, the MX-ship could proceed to the naval facility on San Clemente Island where the warheads could be loaded; this avoids having warheads stored in or near a heavily populated area (San Diego), and permits a high degree of military security to be maintained. In the case of Norfolk, the MX-ship could proceed from Norfolk to the Little Creek Naval Amphibious Base, for these operations. In addition, it was found in Project HYDRA operations that many operations thought infeasible to handle at sea, underway, were in fact not too difficult at all. For this type of ship, roll and pitch are generally slight, and even operations involving handling heavy loads with cranes were carried out without any difficulty.

#### 4.4 Use of Existing Port and Naval Base Facilities

The use of more or less "conventional" surface ship port facilities, as opposed to specialized facilities tailored to a specific class of submarine, yields definite cost advantages. Also, the fact that the ships will have their own loading cranes means that a bare pier<sup>or barge</sup> is usable, provided it has the required load carrying capacity. Even at advance bases, the ship could perform at a high level of efficiency in loading stores, spares, or even missiles contained in their capsules/shipping containers.

Figure 4-1  
PORTS, NEAR-TERM AND FAR-TERM

- o Main Bases
  - Norfolk, Virginia
  - Biloxi, Mississippi
  - Pearl Harbor, Hawaii
  - San Diego, California
  
- o Advance Bases/  
Transloading Sites
  - Guam (Marianas Is.)
  - Kwajalein (Marshall Is.)
  - Anchorage, Alaska
  - Tauk (Caroline Is.)
  - Pago Pago (American Samoa Is.)
  - Christmas Is.
  - San Clemente Is., California
  - Chatham Strait, Alaska
  - Galveston, Texas
  - Key West, Florida
  - Mobile, Alabama
  - Roosevelt Roads, Puerto Rico
  - Narragansett Bay, Rhode Island
  - Penobscot Bay, Maine
  - Puget Sound, Washington

Note: All of Main Bases have shipyard facilities available

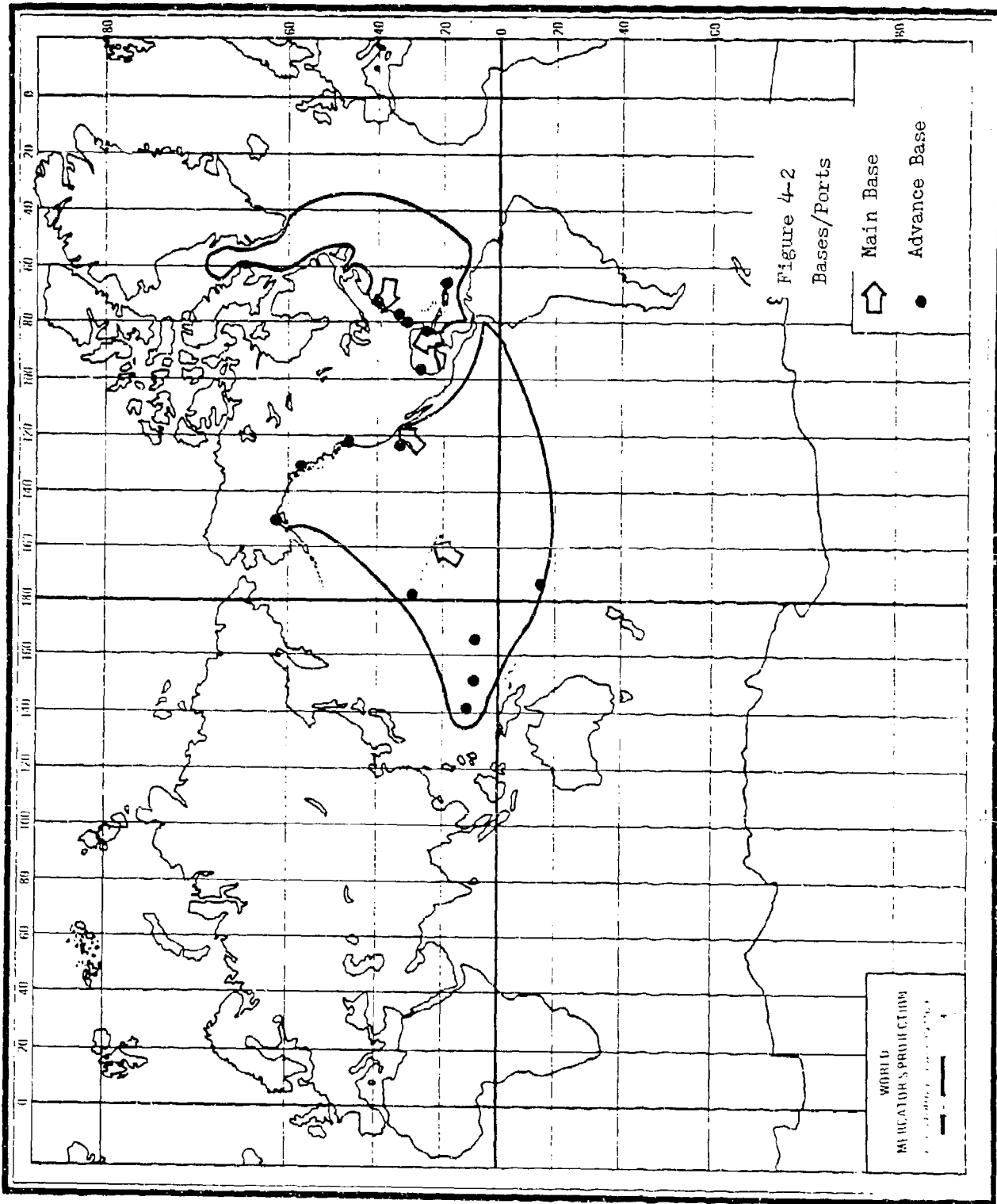



## CHAPTER 5 DEPLOYMENT

### 5.1 General

Deployment areas for the Surface Ship MX Force are selected so as to gain the maximum possible strategic and tactical benefits over the USSR, while denying him these same benefits to the maximum extent possible. We wish to create difficulties and problems for our enemies, while maintaining the initiative to select the most favorable circumstances for ourselves. The most important factor in dealing with mobile forces is consideration of their effective range, or reach. An enemy may have a very effective weapon, or a weapon platform with weapons on it, but if he cannot reach you with it, it is not of much use to him.

Sea-basing a strategic missile system puts your opponent on the defensive, a priori. He is forced to react to your choice of operating areas, and to your tactical maneuvers. The initiative always lies with the side with systems in being - not on the drawing boards - capable of both operating and attacking at longer ranges than any force the opponent can mount. A good analogy can be found in the case of pugilists; the boxer with the longer reach, other things being equal, will generally win the bout.

With the sea-basing of long-range strategic missiles, the U.S. can regain the strategic initiative; with land-basing we cannot. Land-basing our strategic missiles on our own soil effectively pins them down and we put ourselves irrevocably on the defensive. With land-basing, our enemy will know within narrow bounds, the location of the attack corridors through which our missiles would approach him, since he knows they would be launched from a fairly restricted area in our western states. With sea-basing, on the contrary, he will not know in which direction to orient massive warning radars or ABM systems. He will have to make them omni-directional, at great expense, since an attack could come at him from any point of the compass.

Rear Admiral George H. Miller, USN ret., put it very aptly when he said "Good strategy arranges for battles to be fought elsewhere than in the land

one seeks to preserve and defend."<sup>1</sup> Sea-basing provides this advantage, while land-basing precludes it.

## 5.2 Definition of Operating Areas

The first step in defining an operating area for a long-range weapon system is to determine the limits of the area within which you can effectively launch an attack on any enemy target. Assuming a hypothetical 7500 nm range sea-launched missile, we have estimated that there are roughly 73 million nm<sup>2</sup> of ocean within effective range of every point within the Soviet Union. For a hypothetical 6500 nm range weapon, the effective operating region covers about 55 million nm<sup>2</sup> of water. (An area of 73 million nm<sup>2</sup> comprises about half the total area of the earth.) See Figure 5-1

Using a globe of the world, and the basic ocean area of 73 million nm<sup>2</sup> mentioned above, we have defined a total operating area which avoids approaching too closely unfriendly bases or territory; this area is marked as Operating Areas I and II in Figure 5-2.

Area I is designated as the Primary Operating Area and contains regions where many advantages accrue to our own operating forces and many disadvantages would be experienced by the Soviets. Primarily, we have bases in this region, and he doesn't.<sup>2</sup> From these bases, we can support the MX-Ship force with everything from land-based airpower, to surface naval units or submarines.

Area II can also be used for operations, with benefits for one side or the other not so clearcut as in Area I. Still, with caution and careful mission planning this area can also be effectively used, capitalizing on the long range, endurance and autonomy of the MX-Ship. To re-emphasize the importance of base locations, we have repeated Figure 4-2 as Figure 5-3, showing how they fit into Operating Area I.

Unless a great many changes in national alliances or boundaries occur within the next two decades, it is likely that the operating areas will be valid for both the near-term and far-term time periods.

1. George H. Miller, Letters to the Editor, Washington STAR, Sept. 13, 1980
2. An exception might be noted in the case of Russian bases in Cuba.

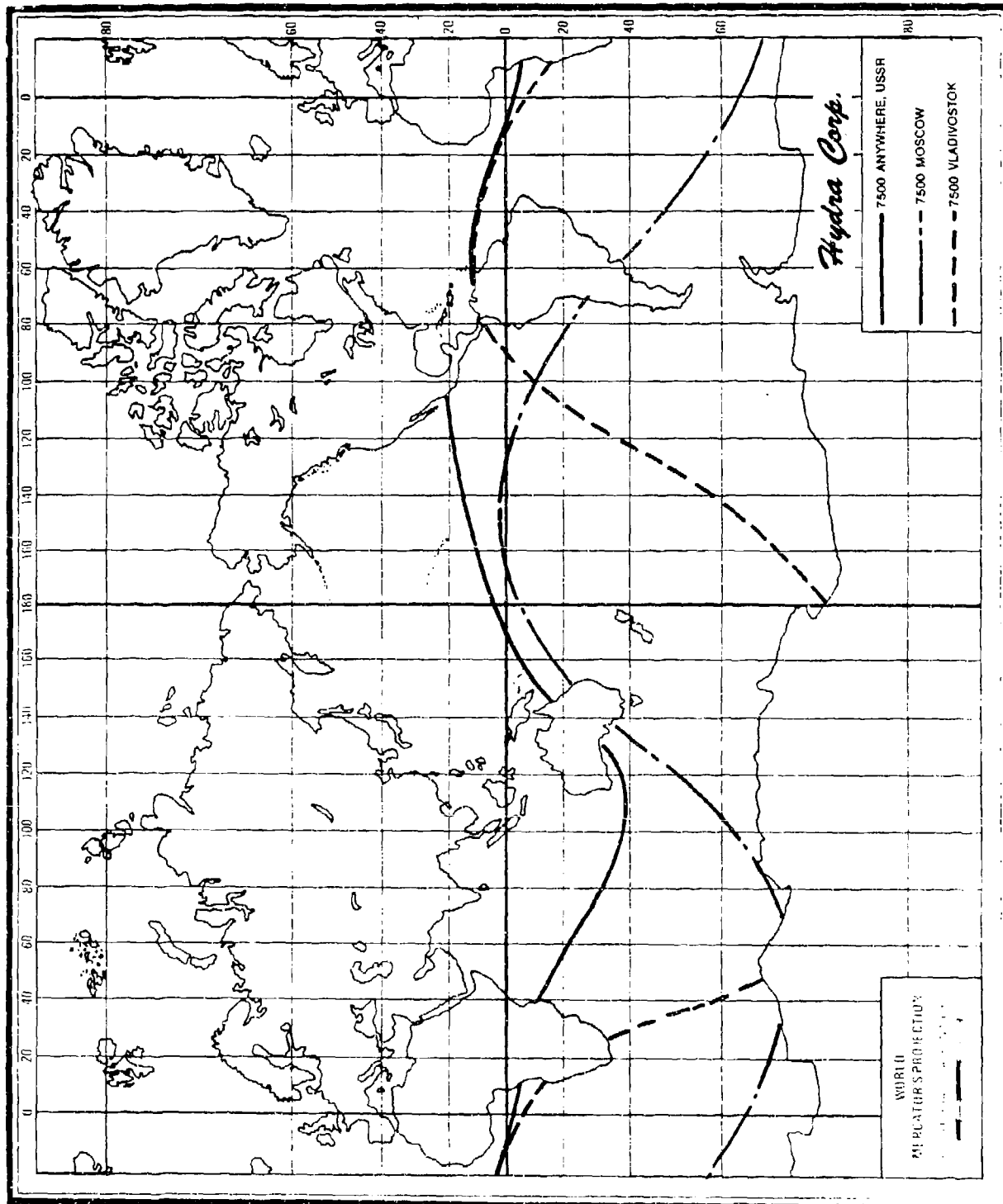

Figure 5-1 : 7500 nm Hangelines

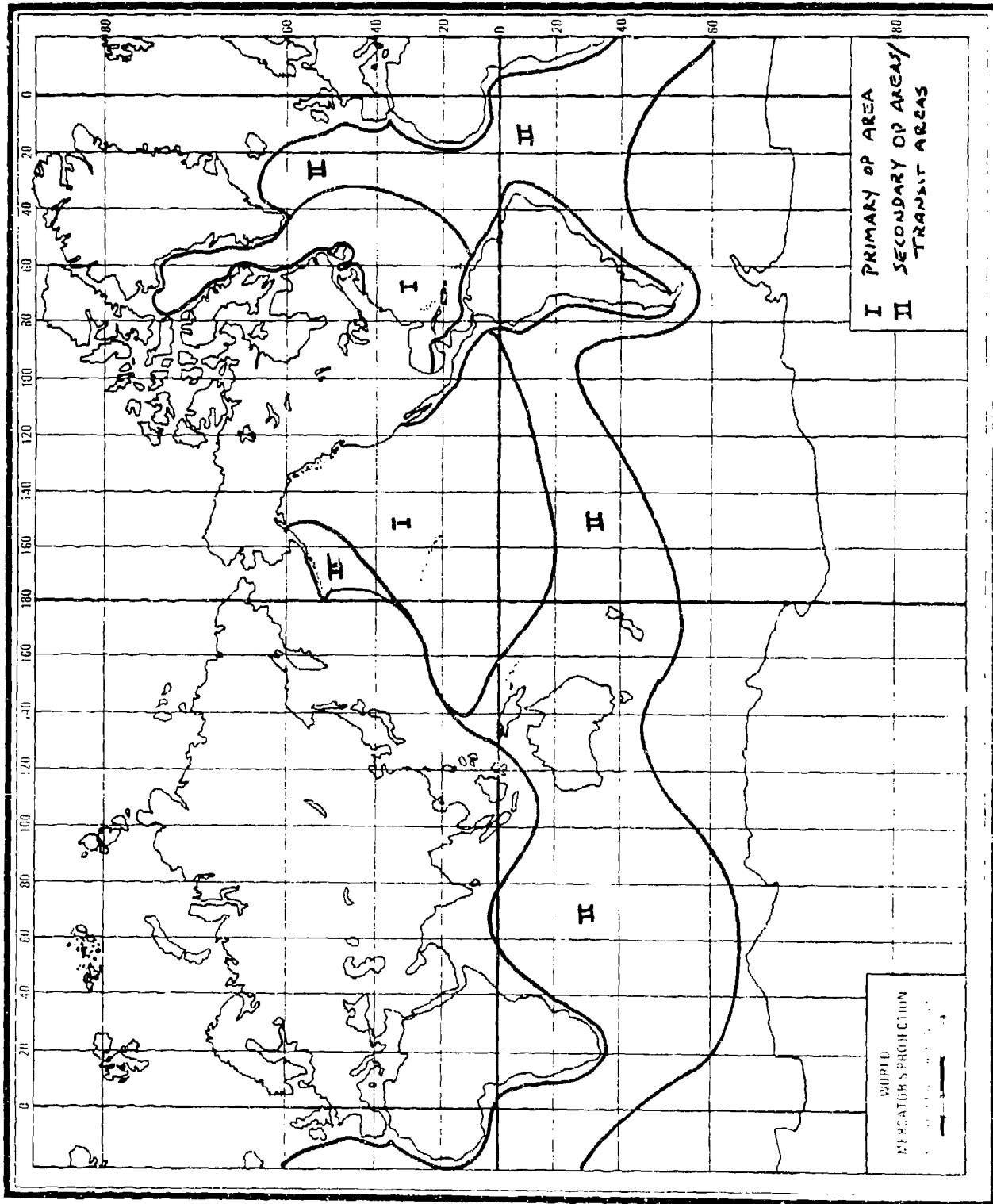

Figure 5-2 : Operating Areas

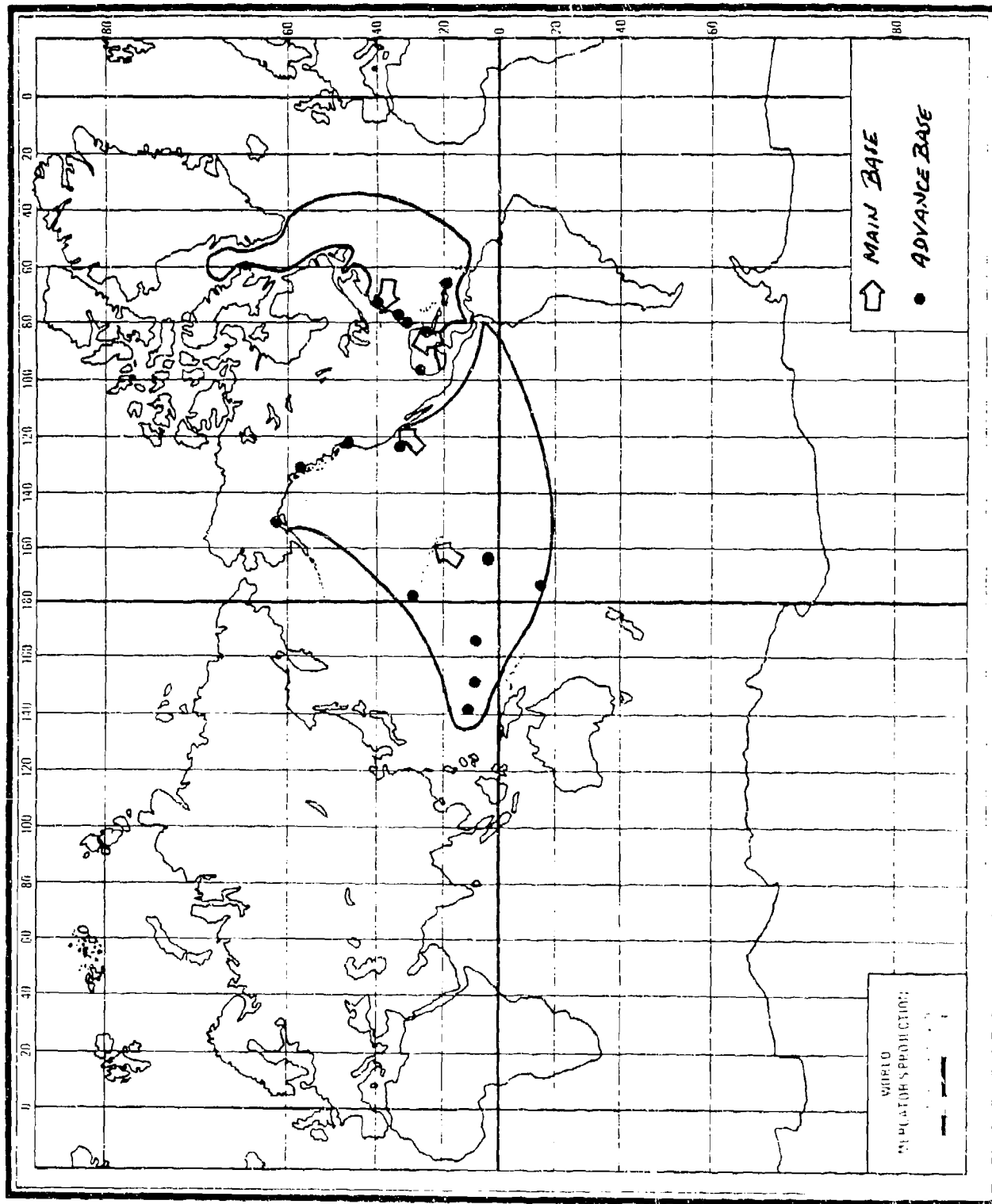

Figure 5-3 : Base Locations

## CHAPTER 6

### PERSONNEL

#### 6.1 General Considerations

The economic and human conditions existing in the United States today exemplify the high standard of living which American citizens enjoy. Wage scales for U.S. workers and military personnel are both higher than in most of the rest of the world. The cost of major enterprises, military as well as industrial, is largely driven by labor costs. The more advanced maritime countries have demonstrated repeatedly how efficiently labor can be utilized on large merchant ships- cargo containerhips, tankers, and the like. This is largely done through automation, and advanced concepts in cargo handling. The same principles can be applied, and the same general type of ship can be used for handling MX missiles, which is essentially another, albeit more deadly, type of freight than handled by conventional merchantmen.

The overall system is designed to use the minimum of support personnel, with most of these being located only at the four major bases. At the advance bases and anchorages, the ship's crew would be used, with heavy lift and transfer of missiles being accomplished using the ship's cranes. Since the missiles are intended to be put into the water in water-tight containers anyway, it is possible to shift the containerized missiles using an offload-float-reload operation, to other ships, to confuse the enemy. Offloading from the deck of the SL-7 type MX ship to the deck of another containerhip should be no problem, without going the water route. Using the offload-float reload-process, missiles could be shifted to a number of standard Navy amphibious ships. The missile support crews would go with them.

Crew manpower requirements for both near-term and far-term MX ships are given in Figures 6.1 and 6.2 respectively. Detailed estimates of support manpower requirements are beyond the scope of this study. Aboard the ships, dual crewing is necessary, due to the high recycle time at sea (over 90%), for the same reasons it is necessary in the SSBN program.

## 6.2 Near-Term Ship Manning

For the near-term, with the SL-7 type ship, it appears that a total crew size of 200 officers and enlisted men could perform the assigned missions. Dual crewing is used. The missile crew size is commensurate with needs for accomplishing necessary missile checkout and minor repairs/adjustments. It also includes additional crew members to man gun and missile batteries for self defense functions. A somewhat larger Operations Department is needed due to the need for critical and redundant communications, more stringent navigation and maneuvering requirements, and general lookout requirements. Total system ship crew requirements are thus  $200 \times 30 \times 2 = 12,000$  officers and men.

## 6.3 Far-Term Ship Manning

The crew for each MX-SES is estimated to be 159 officers and enlisted. See Figure 6.2. The estimated number of SES platforms would be 45. Thus, there would be  $45 \times 159 \times 2 = 14,310$  in the SES force. If the SES-MX's operated out of advance bases, there would be additional base support personnel requirements. If they used SL-7 type mother ships, the crew factors previously given for that type ship would apply. If 15 SL-7's were retained as mother ships, then the total personnel requirements would be  $14,310 + 15 \times 2 \times 200 = 20,310$  officers and enlisted.

Figure 6-1  
 MX SHIP SAMPLE CREW BREAKDOWN AND ADMINISTRATIVE ORGANIZATION  
 (Near-Term)

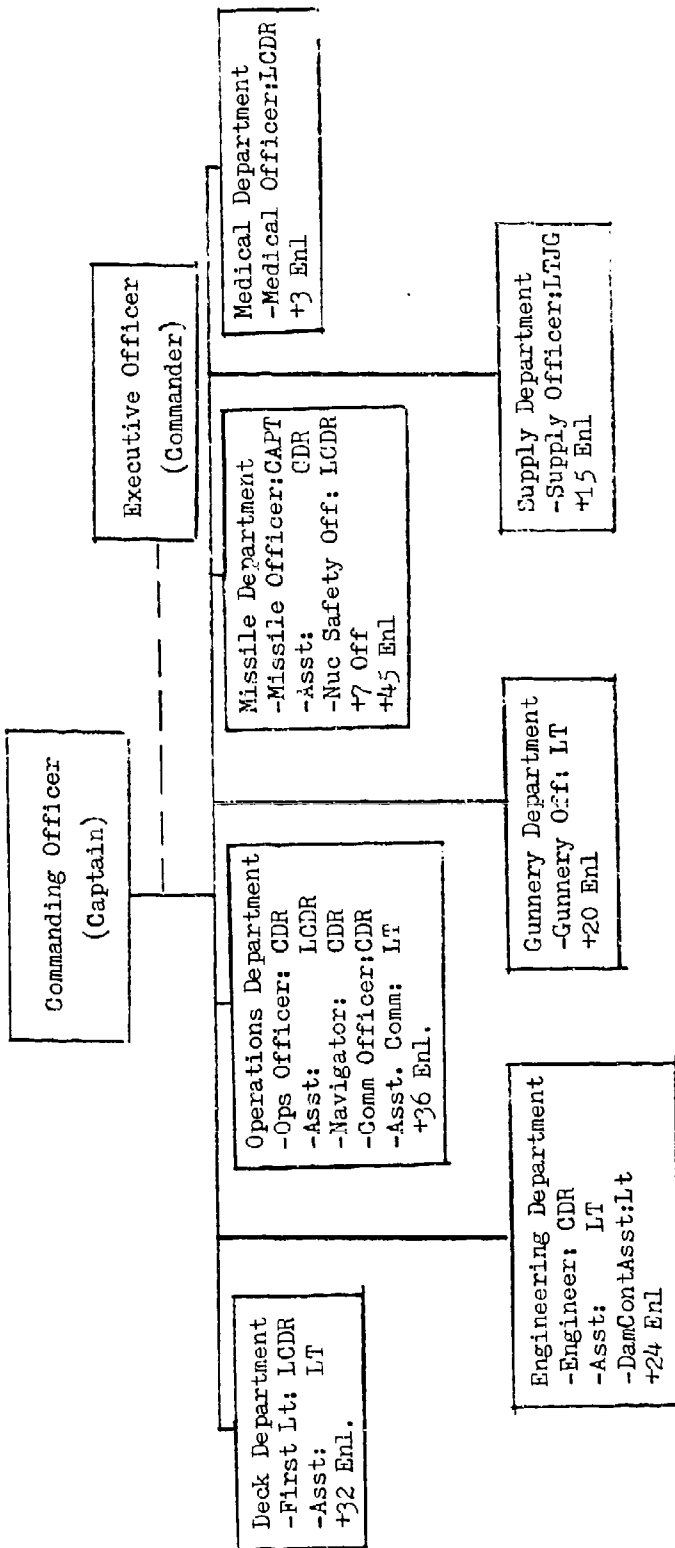

Total Officers:	25
Total Enlisted:	<u>175</u>
Total Crew:	200



Figure 6-2  
 MX-SES SAMPLE CREW BREAKDOWN AND ADMINISTRATIVE ORGANIZATION  
 (Par-Term)

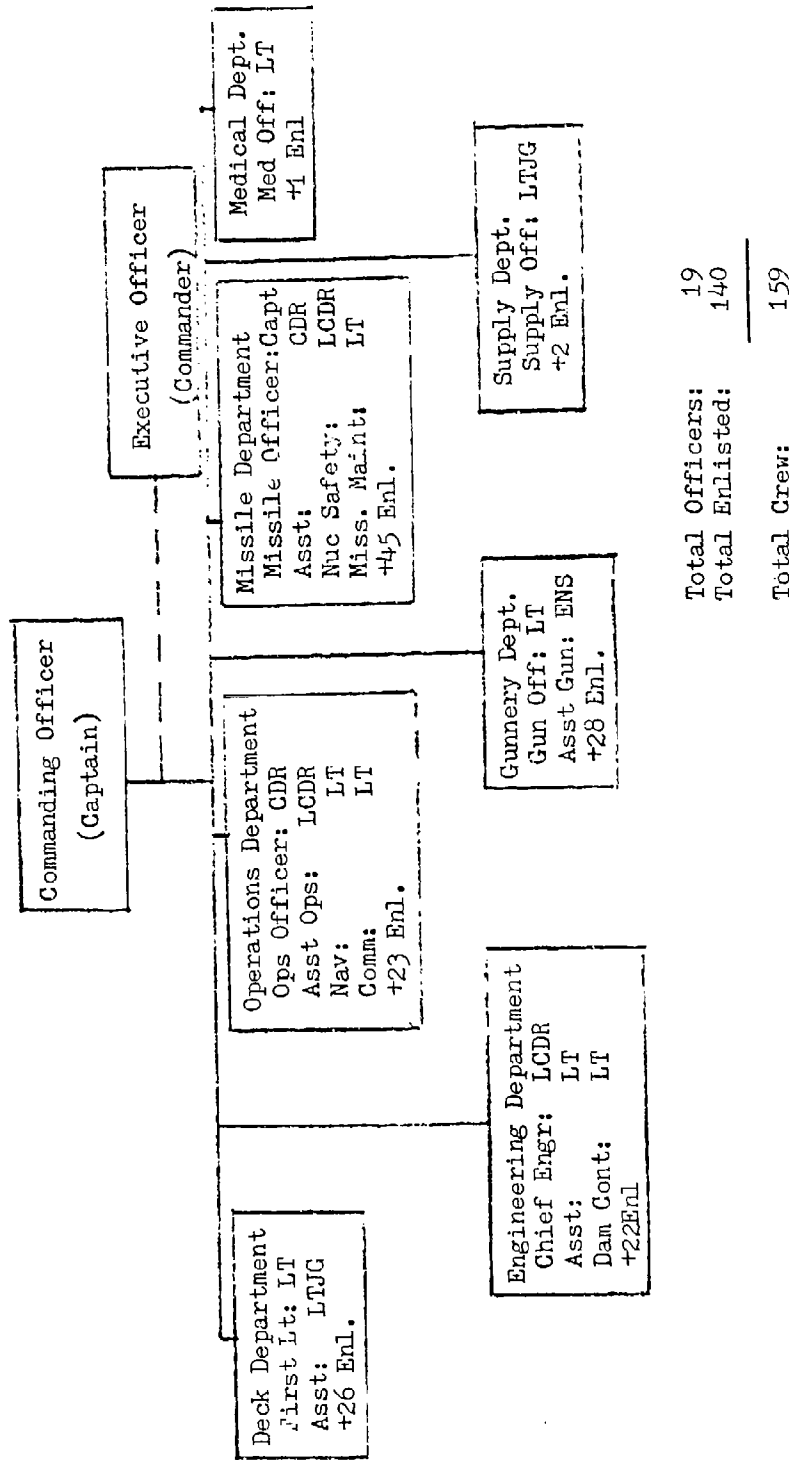

Total Officers:	19
Total Enlisted:	140
<hr/>	
Total Crew:	159

## CHAPTER 7

### COSTS

#### 7.1 Costs: General

Costing of the entire system has been based on a number of sources. These sources included Navy sources in OPNAV for amphibious ship costs, naval architects and shipbuilders for containership and SES cost figures, a study performed for DARPA by Systems Planning Corporation on small submarine and missile system costs, and consultants on space and other support type costs. Only Near-Term Systems were costed.

#### 7.2 Ship Costs

The major system cost item appears to be the MX-Ship, the mobile support platform for the missiles. This is not surprising, as it follows the trend for the Linear Grid land-mobile system, the small submarine and SUM systems, and other closely related systems such as the B-1 manned bomber strategic system. See Figure 7-1 for the System Cost Summary.

Two of the ship options were based strictly on Navy amphibious support ships which are presently in operation in the fleet. These are the Landing Ship Tank (LST) Class and the Dock Landing Ship (LSD or LPD) Class. In order not to impact on existing Navy missions or commitments (or USMC missions or commitments) it was assumed that new construction, dedicated ships of this type would be procured. They would be operated solely as an arm of the US strategic forces, and dedicated to the strategic mission with no requirements or cost-sharing arrangements for other collateral functions.

Two options were based on the present availability of eight fast containerships being purchased by the DOD for about \$36M each. The characteristics of this unique ship are described elsewhere in this report and make it a valid and credible contender for the mission after modifications in some areas such as installation of extra damage control and fire-fighting equipment, provision for extra berthing and messing, and converting some ballast tanks to fuel oil tanks. The first sub-option considered in this

category was a construction program to acquire 22 additional unmodified (as far as basic size) SL-7 ships. This would bring the fleet total to 30 ships. The second option was to operate with the original eight SL-7 ships, but the 22-ship construction program would be designed around a reduced size (800 ft long, 29,000 LWD tonnage) SL-7 at a lower total cost. Finally, a hypothetical fleet is suggested with a much more optimized construction program based on a ship specifically tailored to the MX-carrying mission. It would draw heavily on a blend of the best in both commercial and naval ship construction practice. It would be a smaller ship than even the reduced-scale SL-7, but still very high speed: the specification figures being around 18,000 tons LWD, speed 36 knots, and the nominal missile load of eight MX missiles with an overload capacity of twelve missiles. See Figure 7-2 for amphibious ship costs.

### 7.3 Missile Costs

The missile costs are based on a total missile production of about 350 missiles; this includes all R&D, and all operational test missiles for practice firings. The SPC estimates of 450 missiles required (for an operating force of only 200 missiles) was considered somewhat excessive.

### 7.4 Bases; Costing

The base cost can be held down by using many existing base facilities, except where special nuclear weapons assembly, checkout, storage, and repair facilities are required by regulation. Base costs are further reduced, through provision of self-contained loading cranes on board the MX-ships capable of handling the missile in its container or capsule. For the advance bases, which in many cases are simply anchorage areas, there would be no cost incurred, or minimal costs, at worst.

### 7.5 Capsule Costs

The capsule cost estimates of SPC are considered excessive by the HYDRA corporation, in the SPC study. Accordingly, the costs of capsules, including all R&D, test and production items, has been estimated at \$3.0B. (The HYDRA Corporation's consultant, Mr. Kamalian has designed and built missile capsules, and holds several patents in this area.)

#### 7.6 Nav aids Costs

The HYDRA Corporation accepts the SPC cost figures on IGPS transmitters and bottom acoustic sensors. However, we have added the cost of four additional satellites plus boosters, to implement the augmented (tactical supplement) GPS system. The ground portion of GPS remains the same, and the normal, circular, 12 hour satellites need not be affected. As a matter of fact, overall coverage in the Western hemisphere should be greatly improved for all users with this added capability (although we have made no attempt to amortize costs over a wider user population.)

Note: The ATLAS-AGENA used to launch the standard, 12-hour circular GPS satellites is not sufficient to place the higher orbit tactical supplement GPS satellites in orbit. They would take a TITAN III booster, and this cost has been included in our figures.

#### 7.7 Strategic Weapons Systems Costs

The figures estimated by SPC for this category were considered a bit low, so we have increased them to 4.0B.

#### 7.8 Total System Costs; By Category

A summary of total system costs for the Surface Ship MX System is given in Figure 7-1, by category.

#### 7.9 Backup Cost Figures

Backup cost figures used as a basis for calculation were obtained from a variety of sources. The Navy amphibious ship cost figures were obtained from NOF-372 in the Office of the Chief of Naval Operations, and are shown in Figure 7-2. The SL-7 cost basis is included as Appendix A to this report; its source is the J.J. Henry Co., Inc., designer of the ship. The SES-MX cost figures may be found in Appendix B along with other data on this Long-Term SES candidate MX carrier; its source is the marine subsidiary of the Rohr Corp. (Rohr-Marine, Inc.)

7.10 Total System Costs, by Ship Option; Near-Term (10-year life cycle)

The total system cost, as a function of the type of ship option selected, can be summarized in the following table:

<u>Option Selected</u>	<u>Total System Cost: \$B FY81</u>
67 LST (Landing Ship Tank)	45.1
30 LSD/(Landing Ship Dock, or Amphibious LPD Transport Docks)	37.7
8 Existing SL-7's plus 22 New Constr. 946' SL-7's	35.4
8 Existing SL-7's plus 22 New Constr. 800' SL-7's	33.2
8 Existing SL-7's plus 22 New Optimized MX-Ship	31.2 (?)

7.11 System Costs; Far-Term

Total systems costs for the far term are highly speculative at this time. They will depend not only on the type of ship selected for the near-term (which may become "mother-ships" to SES-MX's) but to the advanced technology SES-MX's also. These craft have not been optimized as to size, configuration, or missile loadout. This area is one which should be looked on as a candidate for further study effort, as the near term system is being developed.

Figure 7-1  
SYSTEM COST SUMMARY

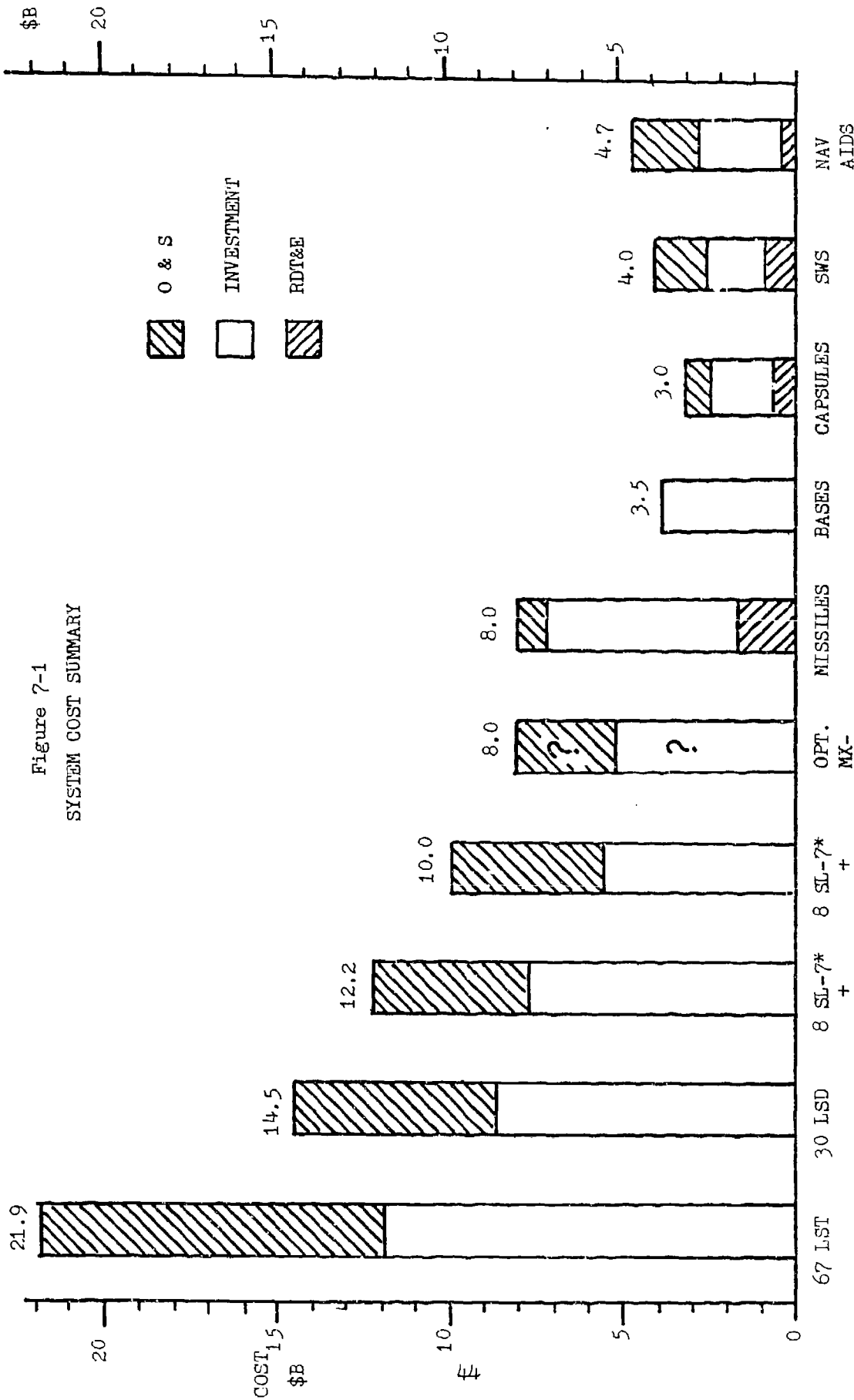

\* Existing SL-7s  
 \*\* 946 SL-7s, New Construction  
 \*\*\* 800 SL-7s, New Construction

SHIP OPTIONS

Figure 7-2

SELECTED AMPHIBIOUS SHIP COSTS (See Notes)

CLASS	ACQUISITION COST (\$M-FY81)		ANNUAL OPERATING COST *(\$M)		LIFE CYCLE COST		OVERHAULS			CREW		
	LEAD SHIP	FIRST FOLLOW SHIP	DIRECT	INDIRECT	TOTAL	ELS (YRS)	COST (\$M)	INTERVAL	DURATION	AVG COST (\$M)	OFF ENL	
LHA	917	741	34.5	8.7	43.2	30	1296	48 mo.	10 mo.	41.0	54	837
LHDX	780	630	29.3	7.4	36.7	30	1101	48 mo.	10 mo.	34.9	50	650
LPD-4	409	293	16.9	4.1	21.0	30	630	48 mo.	9 mo.	22.8	25	390
LPDX	441	318	16.7	4.1	20.8	30	624	48 mo.	9 mo.	25.3	25	390
LSD-36	361	260	12.8	3.1	15.9	30	477	48 mo.	8 mo.	24.1	18	315
LSD-41	390	280	15.9	3.9	19.8	30	594	48 mo.	8 mo.	24.1	20	356
LST	243	176	9.5	2.3	11.8	30 35**	354 413	48 mo.	7 mo.	13.6	13	213

\* INCLUDES OVERHAULS \*\* NRF

- NOTE: 1. Costs are displayed in FY 1982 dollars, except acquisition costs which are in FY 1981 dollars (conversion 82:81=91.9%)
2. These costs are approximations based on the Navy Program Factors Manual (OPNAV-90P-02D Rev. 14 Nov 80) and other data. These costs are not to be considered budget quality.

Source: OP-372

CHAPTER 8  
SYSTEM VULNERABILITY AND COUNTERMEASURES

8.1 Threat: General

The threat which confronts the surface-ship based MX missile force is, basically, that which can be projected by the Soviets to near-intercontinental ranges. Using the improved range capability of the re-designed MX missile (7500 nm) greater stand-off distances may be used for the surface-ship MX platforms. This type of stand-off range eliminates most Soviet ships, virtually all aircraft, and would severely impede the effectiveness even of their submarines.

8.2 Surveillance Systems Threat: Near-Term

The threat from enemy systems may be divided into several categories. We will treat first with the threat represented by their surveillance systems. By themselves, the sensors, intelligence collectors and other surveillance systems are in themselves unable to mount an attack, but they do provide the vital information to naval headquarters and operating units which permit weapons to be brought to bear. Surveillance sensors may provide an MX unit's location with possibly additional elements of information such as course and speed, the number of MX missiles embarked, and the make-up of other forces in the area. Table 8-1 lists types of surveillance systems.

Ultimately, the survival of surface units depends on how efficiently and unerringly the Soviets can maintain a continuous, real-time plot of all the MX surface units simultaneously. The system is required to detect, then identify, and then maintain track without ambiguity even before a weapons system can be maneuvered into position to attack. This is no easy task, because of the many natural and man-made obstacles to perfect surveillance.

The surveillance of MX surface ships is greatly complicated by the existence of large numbers of other surface ships on the world's oceans. These other ships represent the merchant and fishing fleets of the nations of the world. Many times, in crowded areas such as the Mediterranean, or in heavily travelled shipping lanes, the system becomes saturated or the confusion factor becomes unacceptably high. It is estimated that there are over 22,500 ships of 1000 gross registered tons or more in operation.



Of this number, more than 13,000 are at sea on the average. In a sense, these other ships represent decoys for the MX platform ships. And, very importantly, both decoys and real targets are intermingling and in constant motion.

The use of satellites for ocean surveillance will no doubt increase in the future, on the part of both the U.S. and the USSR. The use of this type of satellite and other military support satellite systems will accelerate the development of anti-satellite (ASAT) systems. The Soviets have already demonstrated an operational co-orbital type of satellite interceptor vehicle. The U.S. is following suit with the development of a miniature homing vehicle, which unlike the Soviet system can be launched from a fighter aircraft (the Soviet system requires a large space booster to place the interceptor into orbit). The U.S. system will be capable of destroying Soviet surveillance satellites in low earth orbit. Thus, the U.S. anti-satellite system will go far towards negating the space-based portion of the Soviet ocean surveillance system should war break out.

### 8.3 Weapon System Threat; Near-Term

The other half of the enemy threat package is represented by their weapons systems. These are the forces capable of a direct attack, capable of damaging or killing elements of our own force. These weapons systems consist of surface warships, submarines, long-range aircraft and possibly long range ICBMs launched from within the Soviet Union. Tables 8-2 and 8-3 list the Soviet surface ship and submarine threats respectively. A judgmental threat evaluation is presented for both Operating Areas I and II. This evaluation is based on such considerations as cruising range, top speed, type of propulsion, missile or weapons suites, etc. The threat from long-range aircraft in Area I is felt to be non-existent, and probably very slight even in Area II.

The effectiveness of an attack is generally enhanced by launching at close-in ranges. It is obvious that the shorter ranges can be covered in much less time than the longer ranges, so that the target has less time to maneuver clear of the attack. A surface ship using a short-range attack missile would, in all probability, be more effective than another ship

using a long-range cruise missile.

Given the long stand-off ranges at which the surface ship MX force can operate, with the resultant long distances from Soviet base and refueling facilities, there can be little concentration of force and even less coordination between Soviet attacking elements. Most experienced naval officers interviewed believed that the percentage of MX ships which could even be detected, much less identified and tracked continuously, would be quite low. They considered that the draw-down of the MX ships would take a considerable time- days if not weeks- in the near-term (1985-1990). A great deal of operations analysis needs to be done in this rather complex area which involves so many factors.

#### 8.4 Surveillance System Threat: Far Term

The sophistication and effectiveness of ocean surveillance sensors and systems confronting the surface MX units will increase markedly in the far-term period. Another factor which might increase the effectiveness of ocean surveillance would be the introduction of a Soviet space shuttle, permitting the placement of satellites into orbit more cheaply.

#### 8.5 Weapon System Threat: Far Term

Weapons systems capable of direct kill can be expected to improve in the 1990-2000 time frame, but not to the same degree as surveillance systems. The long-lead times associated with ships, aircraft, and other hardware items means that many of the systems in use will look much like today's systems. We would expect to see (finally) a phase out of the TU-95 BEAR aircraft, with a possible replacement being a long-range pure jet type. More ships will rely on nuclear propulsion, and they will probably be larger, more capable ships, with longer range missiles and few, if any guns or torpedoes. Submarines will virtually all be nuclear-propelled, and will rely more and more on submerged launch air-breathing missiles, although torpedoes will remain as a close-in attack weapon. The speeds with which attacks can be mounted will be shortened, thus making attacks closer spaced and better coordinated.

#### 8.6 Countermeasures: Near-Term

The MX surface units can employ a wide and varied range of countermeasures, particularly against the vital first link of the Soviet threat

which is the surveillance system. This includes the use of natural elements such as night, darkness, rain, cloud cover, fog, and terrain masking along islands, archipelagos or coastlines. These methods can be very effective against passive systems, particularly optical types which require human interaction and analysis. Against active systems, such as radar, the use of jamming and ECM is effective, particularly if it is done from other ships or from nearby land sites. In view of the fact that there will inevitably be time delays in the enemy's system for report-back, analysis, decision-making and weapons platform positioning, a very effective countermeasure is the speed of the MX ship. Probably, in the near-term, it will average out to several hours for the enemy to successfully mount an individual attack with a wide variance in the time interval between initial detection and successful attack, if he has located a target at all. The other very important countermeasure is still distance away from enemy bases and forces. There is not much he can do if he cannot reach the target.

#### 8.7 Countermeasures: Far-Term

The same countermeasures applied in the near-term will apply to the far-term time period as well. The prime countermeasure represented by platform maneuvering speed can be greatly enhanced by using the emergent technology of the surface-effects ship (SES) capable of travelling at speeds up to 90 knots. Longer range-weapons would have great difficulty hitting such a rapidly moving target without very sophisticated homing equipment. Barrage type ICBM attack would appear to be questionable in value, especially if smaller numbers of MX missiles were deployed on smaller but more numerous SES platforms all capable of independent maneuvering.

Table S-1

SURVEILLANCE SYSTEMS CAPABLE OF DETECTING, IDENTIFYING,  
TRACKING MX SURFACE SHIP MOVEMENTS

- o Published Shipping Reports
- o Radio Intercepts and D/F
- o Soviet Bloc Ship Sightings
- o Passive Surveillance Satellites (Photo, TV, IR, ELINT)
- o Active Radar Satellites
- o Port Watchers and Intelligence Agents
- o Eecce and Other Aircraft
- o Trailer Ships or Submarines
- o Observers at Choke Points (Straits, canals, etc.)

Table 8-2

## USSR SURFACE SHIP THREAT SYSTEMS (NEAR-TERM)

Type	Class	No. in Class	Displ.	Prop.	Speed	Range	Weapons	Threat Eval.	
								I	(II)
Aircraft Carrier	KIEV	4 ?	38,000	Conv.	32	13,000(18) 4,000(30)	4 76mm Guns 4 Twin SSN-12 43 Acft & Helos	SL	(M)
Helicopter Cruiser	MOSKVA	2	18,000	Conv.	30	Unknown	4 57mm Guns 18 ASW Helo	N	(M-)
Battle Cruiser	KIROV	2	10,000	Nucl.	32	Unknown	Unknown	SL	(M-) ?
Cruiser	SOVIETSKY SOYUZ	4	32,000	Nuc.	Unknown	Unknown	Unknown	M-	(M+) ?
ASW Cruiser	KRESTA II	10	7,600	Conv.	34	5500(18)	Pri. ASW	SL+	(M-)
Cruiser	KRESTA I	4	7,500	Conv.	35	5500(18)	2 Twin SSN-3B	M-	(M)
Rocket Cruiser	KYNDA	4	5,700	Conv.	35	7000(15)	1 Quad SSN-3B	SL+	(M-)
Large ASW Cruiser	KARA	7	9,500	Conv.	32	8000(15)	8 SSN-14	M-	(M)
Destroyer	KASHIN	19	4,500	Conv.	35	4500(18)	4 SSN-2	SL-	(M-)
Destroyer	KILDIN	4	3,800	Conv.	35	4000(16)	4 SSN-2	N	(SL)
ASW Destroyer	KANIN	8	4,700	Conv.	34	4500(16)	10 21" Torp. Tubes	N	(SL)
Destroyer	KOTLIN	26	3,800	Conv.	36	4000(16)	5 21" Torp. Tubes	N	(SL)
Destroyer	SKORY	33	3,100	Conv.	33	3900(13)	10 21" Torp. Tubes	N	(SL)
Frigate	KRIVAK	24+	3,600	Conv.	32	4000?	8 21" Torp. Tubes 4 SSN-14	N	(SL)

Note: Threat Evaluation is given for Op Area I, then, in parentheses for Op Area II. Code is: SV for Severe, M for Moderate, SL for Slight, and N for Nil. Pluses and minuses indicate usual tilt to high or low side in each category.

Table 8-3  
USSR SUBMARINE THREAT SYSTEMS (NEAR-TERM)

Type	Class	No. in Class	Displ.	Prop.	Speed	Range	Weapons	Threat Eval	
								I	(II) *
Cruise Missile	PAPA	1	7000	Nuc.	26 Surf 30 Subm	Unknown	10 SSN7 Tubes 6 21" Torp. Tubes	SL	(M)
Cruise Missile	CHARLIE II	4	5200	Nuc.	26 Surf 33 Subm	Unknown	8 SSN-7 Tubes 8 21" Torp. Tubes	SL	(M)
Cruise Missile	CHARLIE I	11	4700	Nuc.	17 Surf 27 Subm	Unknown	8 SSN-7 Tubes 6 21" Torp. Tubes	SL	(M-)
Cruise Missile	ECHO II	29	5800	Nuc.	20 Surf 22 Subm	Unknown	8 SSN-12/3 Tubes 10 21" Torp. Tubes	SL	(M)
Cruise Missile	JULIETT	16	3550	DE	19 Surf 17 Subm	Unknown	4 SSN3A Tubes 10 21" Torp. Tubes	N	/ SL
Fleet	ALFA	4	3300	Nuc	16 Surf 42 Subm	Unknown	6 21" Torp Tubes	M	/ SV
Fleet (SUBM Tubes remaining)	YANKEE	3	9300	Nuc	20 Surf 30 Subm	Unknown	6 21" Torp. Tubes	M-	/ (M)
Fleet	VICTOR I, II, III	24	5700	Nuc	16 Surf 31 Subm	Unknown	8 21" Torp. Tubes	M-	/ (M)
Fleet	ECHO	5	5300	Nuc	20 Surf 28 Subm	Unknown	6 21" Torp. Tubes 4 16" Torp. Tubes	M-	/ (M)
Fleet	NOVEMBER	13	5000	Nuc	20 Surf 30 Subm	Unknown	8 21" Torp. Tubes 4 16" Torp. Tubes	M-	/ (M)

Note: Threat Evaluation is given for Op Area I, then, in parentheses for Op Area II. Code is SV for Severe, M for Moderate, SL for Slight, and N for Nil. Pluses and minuses indicate usual tilt to high or low side in each category.

## Chapter 9

### MX Missile Capabilities

#### 9.0 General

The MX missile is, in our opinion, capable of floating launch with very minor modifications, provided the encapsulated launch technique is used. Alternatively, with moderate modifications, a bare (unencapsulated) floating launch is possible with the MX. In the former case, the area to which most attention would have to be paid would be in the guidance system. In the latter, the missiles overall specific gravity would have to be adjusted downward slightly, in addition to the modifications to the guidance system. Even if a capsule launch is used, we still strongly recommend the modification to permit bare launch. It increases the flexibility and alternate launch methods possible, and prepares the way for a more advanced version or family of sea-based weapons.

#### 9.1 Missile Flotation

The ideal range of specific gravity for bare floating launch missiles is from about 0.90 to 0.96. This same set of values applies to the capsule launch, for the missile-capsule combination (regardless of what the missile's specific gravity might be by itself). The center of gravity must lie below the center of buoyancy (i.e., closer to the nozzle tail) in order to maintain a vertical floating attitude.

For the bare launch of an MX missile, we would redesign the forward (nose section) of the missile slightly. The volume would be increased by adding a few feet to the length; some of this extra volume could contain an enlarged liquid propellant/liquid oxidizer tankage capacity. The overall size (length) would be increased somewhat, and the weight increased to a lesser degree.

#### 9.3 Missile Range Extension

We propose to extend the range of the missile to 7500 nm. This would be accomplished mainly through providing more liquid fuel/oxidizer in the upper stage, plus increasing the void in the interface area slightly (between the fourth and the third stage). Although there is a slight performance increase due to the addition of buoyant force during launch,

this benefit will be so small as to be insignificant at the range limits of the missile.

#### 9.4 Guidance Accuracy

A primary concern with sea-based missiles in general is the accuracy which may be obtained. A few years ago, one would have to admit to a rather significant, or severe, degradation in accuracy caused by launch location uncertainty and difficulties in platform alignment due to ship motions (pitch, roll, heave, etc.) With newer time-difference radio navigation techniques, this has changed the outlook considerably. The newer navigation/position fixing systems such as the Global Positioning System (GPS) have advertised accuracies on the order of 10 meters in any direction, and 0.1 feet per second in velocity in any direction. For updating an inertial platform, the GPS performs remarkably well; the two systems complement one another with long-term drifts being removed by the GPS from the inertial platform, and short term periods of jamming or radio interference from natural causes being smoothed by the inertial system. One has a number of options as to where to locate the GPS transmitters. The present USAF planning is to have 18 satellites in 12-hour inclined circular orbits. These satellites would be usable, unless they were negated by an enemy. A backup system would make use of ground-mounted GPS transmitters, located on U.S. territory or possessions. They would not need to be turned on except for periods when they were needed (missile attack), so it would be difficult to pre-target or negate them. We are recommending that in addition to these two deployments of GPS-like transmitters, an additional deployment be made in the Primary Operating Area. We would place four satellites in the "rotating-Y" array originally proposed in 1970 for the 621-B System (a precursor to the present GPS); this array would be centered at 135° West Longitude. Actually, one of the satellites would be in synchronous equatorial orbit at 135° West, with the other three in 24-hour elliptical orbits (appearing to rotate around the center satellite). Being outside the normal surveillance limits of Soviet ground sites, and at a very high altitude, it appears that for the near-term at least, these satellites should be fairly immune to Soviet ASAT attack. It would be highly unlikely, in our opinion, that all three of



these GPS arrays could be knocked out simultaneously. The added rotating-Y array could be left on all the time, as would be the regular circular orbit satellites. This would enhance the accuracy and redundancy level for the entire Western hemisphere. All the civilian and military users of GPS in the Western Hemisphere would thus get a continuing benefit from this system.

#### 9.5 Estimate of Jettison-to-Launch Time Interval

We estimate that the MX missile, whether encapsulated or bare, could be fired from a near-vertical (less than  $10^{\circ}$  off vertical) attitude within one minute following release from the MX-ship (i.e., from the time the drop into the water commenced). There will probably be a heaving motion (up-and-down movement); this can be alleviated by simple folding damping plates which can spring out into position as soon as the missile or capsule is clear of the ship. In the case of an encapsulated missile, these damping plates would be attached to the lower end of the capsule; in the case of a bare launch, they would be attached to the first stage nozzle seal, and would be blown clear and sink on main stage ignition.

#### 9.6 Other Missile Selections for Sea-Based Systems

We recommend immediate investigation of other missile selections for an early IOC capability using surface ships and floating launch methods. Specifically, the following operational or near-operational missiles could be quickly modified for sea-launch, without waiting for the full-term MX development. When the MX development is completed the (floating-launch) MX's could replace these interim systems. These missiles which could be so modified are:

- (a) POSEIDON
- (b) TRIDENT
- (c) MINUTEMAN II and/or III

Figure 9-1

REPRESENTATIVE LOCATION OF IGPS TRANSMITTERS

I. Caribbean/Gulf of Mexico Area

Brownsville, TX  
Brooks AFB, TX (San Antonio)  
Corpus Christi NAS, TX  
Bergstrom AFB, TX (Austin)  
New Orleans, LA  
Keesler AFB, LA (Biloxi)  
Eglin AFB, FL  
Pensacola NAS, FL  
Tyndall AFB, FL (Panama City)  
Macdill AFB, FL (Tampa)  
Homestead AFB, FL (Homestead)  
Key West NAS, FL  
Guantanamo NAS, Cuba  
Roosevelt Roads Naval Base, Puerto Rico  
Mayaguez, Puerto Rico  
Culebra Is, Virgin Islands Group  
St. Croix, Virgin Islands Group  
St. Thomas, Virgin Islands Group

II. Pacific Area

Hickam AFB HA (Honolulu)  
Hilo, Hawaii Island  
Kauai, HA  
Molokai, HA  
Maui, HA  
Midway Island  
Wake Island  
Gardner Island  
Johnston Island  
Palmyra Island  
Christmas Island  
Anderson AFB, Guam  
Pago Pago, Am. Samoa  
Canton Island  
San Clemente Island  
San Nicolas Island  
Santa Cruz Island  
Vandenber AFB, CA  
Monterey CA NPS  
Oakland CA, NAS  
Travis AFB, CA  
Salem OR  
McChord AFB (Tacoma)  
Whidbey Island WA NAS  
Ketchikan, AL  
Anchorage, AL  
Sitka, AL  
Kodiak, AL  
Unimak, AL  
Adak, AL

Figure 9-1 (concl)

REPRESENTATIVE LOCATIONS OF IGPS TRANSMITTERS (cont.)

III. Atlantic Area

Miami, FL  
Patrick AFB FL (Cocoa Beach)  
Jacksonville NAS, FL  
Charleston AFB, SC  
Myrtle Beach AFB, SC  
Pope AFB, NC  
Camp Lejeune NC USMC  
Oceana NAS, VA (Virginia Beach)  
Andrews AFB, MD  
Dover AFB, DL  
McGuire AFB, NJ  
Bethpage, LI, NY  
New London, Conn, USNS  
Newport RI, USNavWarCol  
Hanscom AFB, MA (Bedford)  
Pease AFB, NH (Portsmouth)  
Prospect Harbor ME (NavTrackingSta)  
Argentia NAS, Newfoundland

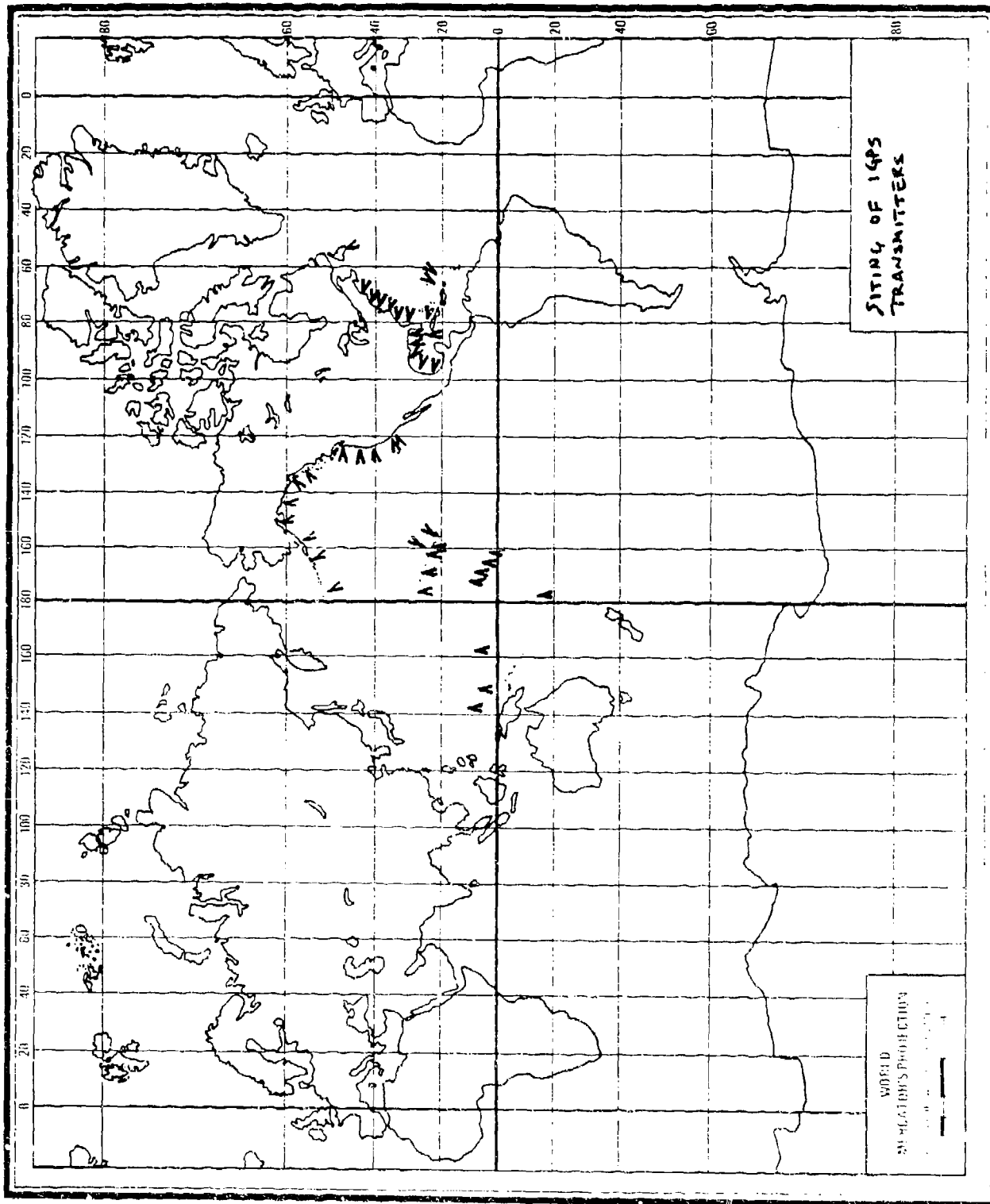

Figure 9-2: Representative Siting of IGPS Transmitters

## CHAPTER 10

### MX SHIP STRATEGIC C<sup>3</sup> CONSIDERATIONS

#### 10.1 General

The purpose of this chapter is to briefly address strategic communications by which the NMCS may exercise command and control over MX ships during the various stress regimes of pre-attack, trans-attack and post-attack. The approach will be to use SSBN strategic communications requirements and capabilities as a comparison baseline. This approach is especially helpful during the critical trans-attack period. See Table 10.1.

#### 10.2 Requirements

One may assume (1) that MX ship deployment areas will be naturally more widespread than SSBN areas - implying longer-range communications; (2) that delivery times for emergency action messages (EAM's) to MX ships must be shorter than times to reach SSBN's; and, (3) that "report-back" ship-to-shore communications must play a much larger role than traditionally required for SSBN's. All these factors are traceable to an anticipated shorter survival time period for the MX surface ship as compared with the SSBN.

#### 10.3 Capabilities

The MX ship enjoys the basic advantage of being able to operate radio antennas above the water surface without affecting (at least, on reception) ship survivability. With an exposed antenna, received signals at the longer wavelengths (HF and lower frequency bands; sub-ionospheric propagation paths) will be significantly stronger than with a non-exposed antenna. For reception at shorter wave-lengths (VHF through lower EHF; quasi-all weather satellite relay signals), exposed antennas are very efficient while floating/submerged antennas are marginal (through the military UHF band) or completely useless (higher bands). For transmission, exposed antennas are necessary at all the above wavelengths. Vertical antenna arrays can be easily installed on board the SL-7 class vessel. Longer lengths can be raised through use of balloons or even small floating launch probe rockets. The rocket launch could be delayed until the ship is clear to avoid giving away ship

position. Underwater acoustical communications are not thought to be practicable in the near-term, nor are satellite borne laser communications devices. Obviously, the minimum antenna exposure imposed on SSBN operations does not apply to MX ships, and much stronger received signals can be obtained at a given range, or in adverse nuclear environments at a given range. The bit error and repeat rate would thus be much lower.

For snip-to-shore report-back, MX ship exposed antennas allow the transmission at all but the longest of the above wave-lengths. Practical operation must be consistent with countering enemy intercept of transmitted signals by D/F or other means of signal exploitation such as satellite intercept, aimed at locating the transmitter platform. Viable MX ship report-back options should emerge from a detailed study of this problem.

Finally, one may expect that satellite relay communications will play an increasingly large role in MX ship strategic communications, especially in the pre-attack period. Possibly, it would be usable in later stages of post-attack. Optimally, one would like to exploit the redundancy advantages of both VLF and satellite relay communications for reliable strategic communications.

Summarizing, there appears good reason to expect that MX ship strategic communications, although at first glance more demanding than SSBN strategic communications, may actually turn out to be an easier problem. More quantitative study is needed in any case.

#### 10.4 MX Ship Strategic Communications Modes in the Near-Term: Shore-to-Ship

Existing/planned shore-to-ship communications may be exploited for the MX ship as follows:

Pre-Attack: Fixed site VLF; FLTSATCOM/LEASATCOM; Long-Haul HF

Trans-Attack: TACAMO Aircraft VLF-LF relay; surviving satellite relay

Post Attack: Long-Haul HF (mobile sites surviving in CONUS); multi-node

HF relay via surviving ships at sea; surviving satellite relay.

#### 10.5 MX Ship Strategic Communications in the Near-Term: Ship to Shore Reportback

In all of the methods selected, careful attention must be given to achieving low probability of intercept (LPI) of direct transmissions (e.g. satellite uplinks).

Pre-Attack: FLTSATCOM/LEASATCOM

Trans-Attack: Surviving satellite relay; VLF transmission helo or  
balloon suspended vertical wire antenna from the ship.

Post-Attack: Same as Shore to Ship

#### 10.6 MX Ship Strategic C<sup>3</sup> in the Far-Term

Improved satellite communications, higher performance TACAMO aircraft, and possibly the completion of the SSS Survivable Strategic Satcom System will aid in alleviating problems in the Far-Term. Also, there is a requirement for a survivable satellite launch system for reconstituting satellite relay links. One way this could be done is through use of vertical floating launch (HYDRA) satellite boosters, deployed in exactly the same manner as the MX missiles are launched. This could be done quickly, possibly with slight redesign of the MX missile itself, making it into a satellite booster of moderate to good payload capability. This possibility for reconstitution deserves the most careful scrutiny, as a collateral function for MX ships.

#### 10.7 Conclusions

It is concluded that:

- o MX Ship strategic communications capability is technologically easier than SSBN communications, in that above-water antennas may be freely employed to provide much improved signal efficiencies.
- o All SSBN and some bomber strategic comm systems are probably exploitable for MX Ship communications purposes.
- o MX Ship deployment may offer synergistic benefits used with ships, SSBN's and bombers. MX ships could be used as relay nodes to SSBN's as well as to reconstitute comsat capabilities as previously suggested using floating launch boosters.

#### 10.8 Recommendations

It is recommended that:

- o Quantitative modelling and assessment be conducted of existing and planned strategic comm systems to support MX ship strategic comm.
- o Synergistic improvements with other strategic forces be studied, for full utilization of MX Ship potential
- o The survivable launch capability for reconstitution of Satellite communications through use of floating launch techniques should be studied.

TABLE 10-1

## STRATEGIC COMMUNICATIONS STRESS REGIMES

<u>Pre-Attack</u>	<u>Trans-Attack</u>	<u>Post-Attack</u>
<ul style="list-style-type: none"> <li>o Normal ionosphere</li> <li>o Continuing enemy attempts to conduct COMINT and to exploit report-back transmissions for position location purposes</li> <li>o Occasional sabotage attempts against shore-based communications installations</li> </ul>	<ul style="list-style-type: none"> <li>o Severe worldwide disturbance of the ionosphere by numerous high-altitude nuclear bursts</li> <li>o Intensive comm jamming by the enemy</li> <li>o Early destruction of all major fixed-site communications installations</li> <li>o Progressive destruction by nuclear bursts in space, of communications satellites</li> <li>o Intensive enemy efforts at sea to locate, destroy SSBN's, MX Ships</li> <li>o Extensive underwater acoustic reverberations</li> <li>o Creation of extensive dust clouds in atmosphere</li> <li>o Creation of extensive belts of trapped radiation in space</li> </ul>	<ul style="list-style-type: none"> <li>o Healed ionosphere, perhaps back to normal</li> <li>o Greatly reduced enemy threat and activity</li> <li>o Endurance of trapped belts of radiation in space, for weeks or even months</li> </ul>



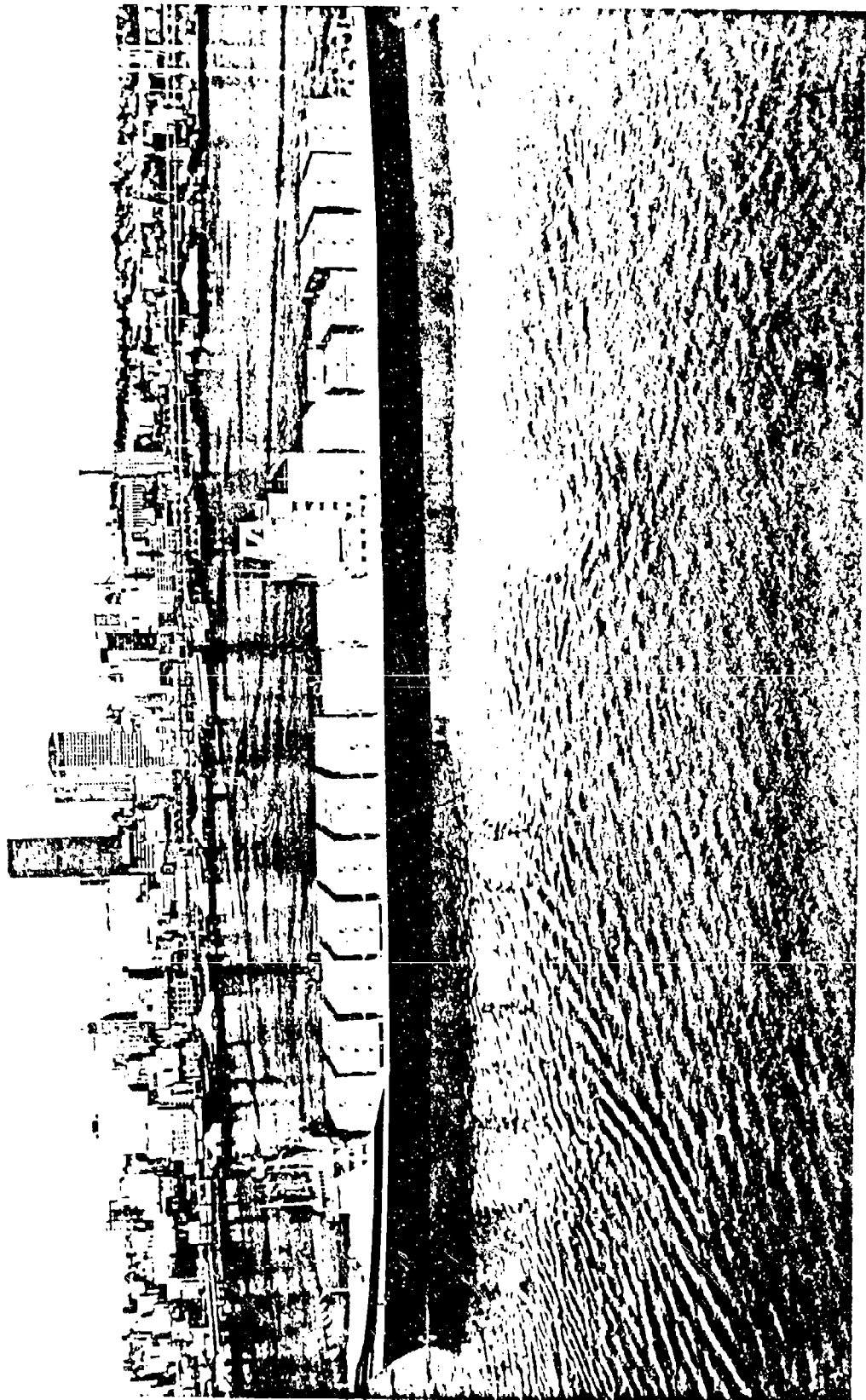

sb-7 Confidentiality